

SEKONIC Illuminance Spectrometer

SPECTROMASTER C-7000

Operating Manual

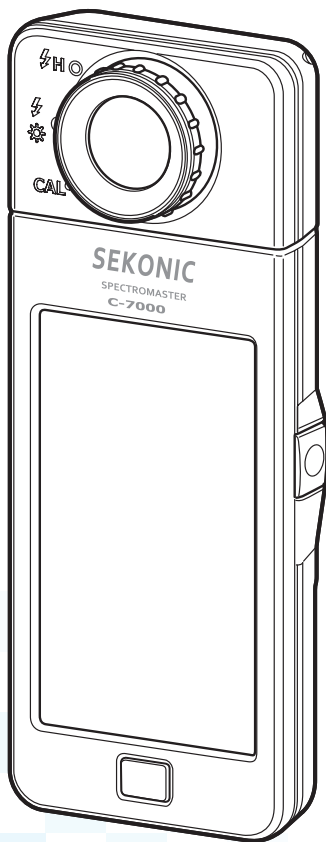

Please read the operating manual carefully to fully understand the features of this product before use and keep it for future use. Keep the operating manual in a safe place.

Congratulations on your purchase of a Sekonic SPECTROMASTER C-7000. Please read the operating manual carefully to properly utilize the many features and benefits of this precision instrument.

The Sekonic SPECTROMASTER C-7000 is a portable spectrometer equipped with CMOS linear image sensor that can measure from 380nm to 780nm. Its large color LCD, conveniently displays correlated color temperature, color rendering index (CRI), chromaticity diagrams and color spectrum of various light sources. The Sekonic C-7000 illuminance measurement complies with JIS Class A standard making it a reliable illuminometer. Its capabilities make it suitable for checking the quality of a light source during manufacturing and inspection processes, as well as measuring the quality of light for various areas such as office environments, construction sites, road lighting, and factory spaces.





In addition, the "C-700/C-7000 Series Utility", included as an accessory of this product, can be used to save data, display measured values and graphs, and perform settings when the meter is connected by USB to computers or tablets.

■ Terminology and trademarks

- Windows is a registered trademark of Microsoft Corporation in the USA and/or other jurisdictions.
- The official name of Windows is "Microsoft® Windows® Operating System."
- Adobe Reader is a registered trademark of Adobe Systems Inc.
- All other company or product names are trademarks or registered trademarks of the respective companies.

■ Safety Precautions

Before using this product, please read this "Safety Precautions" for proper operation.

| | |
|---|--|
|  WARNING | The WARNING symbol indicates the possibility of death or serious injury if the product is not used properly. |
|  CAUTION | The CAUTION symbol indicates the possibility of minor to moderate personal injury or product damage if the product is not used properly. |
|  NOTICE | The NOTICE symbol indicates cautions or restrictions when using the product. Please read all notes to avoid errors in operation. |
|  NOTE | The reference symbol indicates additional information about the controls or related functions. Reading these is recommended. |
|  | The arrow indicates reference pages. |

WARNING

- Infants or toddlers may accidentally wrap the strap around their neck, so please place it in a location out of their reach. There is a danger of suffocation.
- Do not place batteries in open flames, attempt to short, disassemble or apply heat to them, use unspecified batteries, or recharge them (except rechargeable batteries). They may burst and cause fires, serious injury, or damage to the environment.
- Do not use the spectrometer in a place containing flammable or combustible vapors. Otherwise, it may cause a fire.
- Exercise care not to drop fluids on the spectrometer. Also, do not attempt to insert metals into it. Doing so may cause a fire or an electric shock. If any fluid drops on or a metal is inserted into the spectrometer, turn the power switch OFF immediately, and remove the battery (or unplug the USB power cable). Then, consult our Support Center for assistance.
- Do not disassemble or modify this spectrometer. Doing so may cause a fire or an electric shock.

CAUTION

- Do not handle this product with wet hands, or leave it in the rain or in a location where it may be splashed with water, submerged, or come into contact with moisture. There is a danger of electric shock if the "Flash Light Cord (PC) Mode" is used. This may also result in damage to the product.
- Do not attempt to disassemble the product for modification or parts replacement. It may affect measurement results or damage the meter.
- Do not attempt to play the included CD-ROM using an audio CD player. It may impair hearing or damage speakers and earphones.
- Gently tap the meter's LED panel when changing modes or making selections. Using pointed pens or pencils may scratch the LCD screen or damage the product.
- Infants or toddlers may accidentally grab the strap and swing the product, so please place it in a location out of their reach, as the meter may be damaged by impacts.
- Be careful that the neck strap does not come loose when carrying the product, as the meter may be damaged when dropped.
- This neck strap is made of polyester fiber. Please refrain from using the product if synthetic fibers cause your skin to become irritated, inflamed or itchy in order to prevent worsening your symptoms.
- Do not measure a bright object that emits light exceeding the measuring range (wavelength and illuminance). They may damage the optical components and result in inaccurate measurement.
- Before removing or replacing the battery or USB cable, always turn the power switch OFF. Otherwise, the spectrometer may fail.
- Do not place the product on an unstable or tilted bench. Otherwise, it may drop and you may be injured.

■ Polyvinyl Chloride (PVC) cable and cord notice



WARNING

Handling the cord on this product or cords associated with accessories sold with this product will expose you to lead, a chemical known to the State of California to cause cancer, and birth defects or other reproductive harm. Wash hands after handling.

 **NOTICE**

- A protective sheet is attached to the LCD. Peel it off before use.
- Although the LCD monitor is manufactured to very high standards, it is possible to observe a few dead pixels on the screen. This is normal and not a malfunction of the meter.
- Do not use at altitudes above 2,000m (6,561 feet).
- Our company shall not be liable for any data loss caused by, but not limited to, malicious acts and control errors.
- You can install the software on the included CD-ROM only when you agree with all articles in the license agreement that comes with the CD-ROM.
- Be sure not to drop the meter or subject it to sudden impacts, as the meter will be damaged.
- Do not store the meter in areas of high temperature or high humidity, as the meter will be damaged.
- Be careful not to transport the meter from cold to warm moist conditions as condensation will form on the meter and may damage it.
- If the meter is operated in temperatures below -10°C , the response of the LCD will greatly slow down and the display may be difficult to view and read. This will not harm the meter. Also, if the temperature exceeds 50°C , the liquid crystal display will darken and become difficult to read, but when it returns to room temperature it will return to its normal condition.
- If the meter is left in direct sunlight, a vehicle, or near a heater, the unit's temperature will rise and may result in damage. Please be careful when using the meter in these types of locations.
- If the meter is left where corrosive gases may be generated, the gases may affect the product and may result in damage. Please be careful when using the meter in these types of locations.
- In case of disposing the meter, follow the rules of disposal in your area.

Maintenance Notes

- Be careful not to let the Light Receptor become dusty, dirty, or scratched as this may affect the precision of the measurement.
- If the meter becomes dirty, wipe it with a dry, soft cloth. Never use organic solvents such as thinner or benzene.

 **NOTE**

- For used batteries, dispose of them according to the rules of your area, or bring them to a battery recycling shop near you.
 - Insulate plus and minus terminals with tape or other insulation material.
 - Do not remove the covering material of batteries.
 - Do not disassemble the batteries.
-

■ Intended Usage

The meter is designed for:

- Measuring correlated color temperature, deviation, color rendering index (CRI), illuminance, tristimulus value, chromaticity coordinates, dominant wavelength and excitation purity of various lighting sources such as LEDs, organic EL's and projectors.
- Measuring automotive LED headlights and other types of lamps.
- Measuring the illuminance of optical bio-reactions.
- Controlling the illuminance and monitoring spectral distribution of light source for indoor agriculture.
- Evaluating the illuminance, color temperature, and color rendering index of road lighting, indoor lighting, store lighting, and others.

Main features of the C-7000

| Model name | Usage | Features |
|---------------|-------------------------|--|
| C-7000 | Industrial applications | Monitoring and controlling illumination and color of light sources for industrial and environmental applications. <ul style="list-style-type: none"> • Correlated color temperature (1,563K ~ 100,000K) • Illuminance measurement (1 lx ~ 200,000 lx) • Luminous exposure measurement (20 lx·s ~ 20,500 lx·s) • Displayed in accordance with usage <ol style="list-style-type: none"> (1) Color temperature (2) CRI measurements (3) xy chromaticity diagrams (CIE1931 and CIE1964) (4) u'v' chromaticity diagram (CIE1976) (5) Spectrum display (6) Spectral distribution graph display, graph display enlargement function (7) Illuminance/luminous exposure (ambient light/flash light) (8) Color deviation (Δuv) |

■ Intended Users

The intended users of this product are the following.

- People monitoring and quality control of LED, OLED, projector illumination, etc.
- People monitoring and management of illumination during installation and use of lamps used in museums, restaurants, work spaces, etc.
- People controlling color and brightness of illumination used for indoor agriculture.

■ Restrictions

There are some cautions and restrictions regarding the use of this product. Please read and understand the following before using the meter.



NOTE

- The operation of this meter may change without prior notice due to specification changes or other reasons. Therefore, the contents of this operating manual may differ from actual operation of the meter. Please visit www.sekonic.com for the latest information.
 - Cautions regarding safety such as the Usage Precautions and the Safety Precautions comply with the legal and industrial standards at the time of the making of this operating manual. Therefore, the described contents may not comply with current precautions. Please visit www.sekionic.com for the latest version of the instruction manual.
 - The product may contain printing material such as cautions related to safety and printing errors as a supplement to the operating manual.
 - The contents of this operating manual may be reproduced for non-commercial purposes and for personal use only. However, the reproduced material must contain the copyright notice of our company.
 - The screens in this operating manual may differ from the actual displays of the meter you are using. (Colors, letters, etc.)
-

■ Accompanying Accessories

The following items are included with the SPECTROMASTER C-7000. Confirm if any accessories are missing after unpacking.

If something is missing, contact the sales agent.

Batteries (size AA) and a USB cable are not included.

Neck Strap



Quick Guide



Soft Case

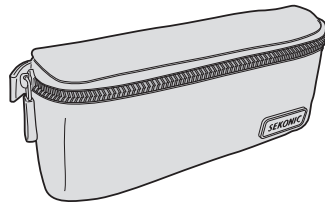

Safety Precaution

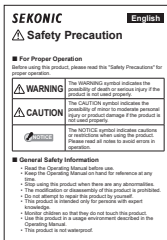

CD-ROM (Operating Manual, C-700/C-7000 Series Utility)

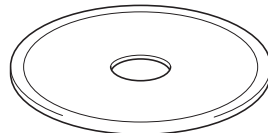

Table of Contents

| | |
|--|-----------|
| ■ Safety Precautions | i |
| ■ Polyvinyl Chloride (PVC) cable and cord notice | iii |
| ■ Intended Usage | v |
| ■ Intended Users | vi |
| ■ Restrictions | vi |
| ■ Accompanying Accessories | vii |
| 1. Parts Designations and Functions | 1 |
| ■ 1-1 Parts Designations | 1 |
| ■ 1-2 Parts Functions | 2 |
| 2. Before Use | 3 |
| ■ 2-1 Attaching the Strap | 3 |
| ■ 2-2 Installing the Batteries | 4 |
| ■ 2-3 Power ON/OFF | 5 |
| ■ 2-4 Checking the Battery Capacity | 9 |
| ■ 2-5 Automatic Power OFF Function | 10 |
| ■ 2-6 Changing Batteries During Measurement | 11 |
| 3. Basic Operation Methods | 12 |
| ■ 3-1 Basic Operation Flow | 12 |
| ■ 3-2 Screen and Operation | 14 |
| ■ 3-2-1 Basic Screen and Operation | 14 |
| ■ 3-2-2 Icon Operation | 18 |
| ■ 3-2-3 Input of Numbers/Characters | 19 |
| ■ 3-2-4 Locking and Unlocking the Screen | 21 |
| 4. Setting the Measuring Conditions | 22 |
| ■ 4-1 Selecting the Measuring Mode | 22 |
| ■ 4-1-1 Matching Measuring Mode with Light Sources | 22 |
| ■ 4-1-2 Selecting the Exposure Time (Ambient Modes Only) | 24 |
| ■ 4-1-3 Selecting the Shutter Speed (Flash Modes Only) | 25 |
| ■ 4-2 Customizing Measuring Displays | 27 |
| ■ 4-3 Selecting the Display Mode | 28 |
| ■ 4-3-1 Displaying in Text [Text] Mode | 32 |

| | | |
|-----------|--|------------|
| 4-3-2 | Displaying in Spectrum Graph [Spectrum] Mode | 35 |
| 4-3-3 | Displaying in Spectrum Comparison [Spectrum Comp.] Mode | 38 |
| 4-3-4 | Displaying in Color Rendering Index [CRI] Mode | 43 |
| 4-3-5 | Displaying in CIE1931 (CIE1964) [CIE1931 (CIE1964)] Mode | 46 |
| 4-3-6 | Displaying in CIE1931 (CIE1964) Comparison [CIE1931 (CIE1964) Comp.] Mode | 48 |
| 4-3-7 | Displaying in CIE1976 [CIE1976] Mode | 52 |
| 4-3-8 | Displaying in CIE1976 Comparison [CIE1976 Comp.] Mode | 54 |
| 4-3-9 | Displaying Setting [Setting] Screen | 58 |
| 5. | Measuring Light Sources [Measurement Screen] | 60 |
| 5-1 | Measurement Method | 60 |
| 5-1-1 | Balancing Color Temperatures of Light Sources | 60 |
| 5-2 | Measurement in Ambient Light Mode | 61 |
| 5-3 | Measurement in Cordless Flash Mode | 65 |
| 5-4 | Measurement in Cord (PC) Flash Mode | 69 |
| 5-5 | Monitor Function (in Ambient Light Mode only) | 73 |
| 5-6 | When [Over] or [Under] is Displayed | 77 |
| 5-6-1 | Display of [Over] or [Under] | 77 |
| 5-6-2 | Changing the Light Range | 78 |
| 6. | Measurement Tool [Tool Box] Screen | 79 |
| 6-1 | Setting Preset Contents [Preset Selection] Screen | 80 |
| 6-2 | Using the Memory Function | 83 |
| 6-2-1 | Naming Measurement Values Being Memorized [Memory Title] Screen | 84 |
| 6-2-2 | Recalling Measurement Results [Memory Recall] Screen | 88 |
| 6-2-3 | Renaming Memory Title [Memory Rename] Screen | 93 |
| 6-2-4 | Deleting Memorized Value [Memory Clear] Screen | 96 |
| 6-3 | Selecting Exposure Time [Exposure Time] Screen | 101 |
| 6-4 | Setting the Shutter Speed [Shutter Speed] Screen | 103 |
| 7. | Meter Settings [Setting] Screen | 105 |
| 7-1 | Setting Items | 105 |
| 7-1-1 | Item List | 107 |
| 7-2 | Customize | 108 |

| | | |
|------------|--|------------|
| 7-2-1 | Item Specifications | 109 |
| 7-2-2 | Selecting the Unit of Illuminance | 110 |
| 7-2-3 | Selecting the Spectrum Y-axis Scale | 112 |
| 7-2-4 | Selecting the Auto Power Off Time | 115 |
| 7-2-5 | Selecting the Backlight Brightness | 117 |
| 7-2-6 | Selecting the Auto Dimmer Time | 119 |
| 7-2-7 | Reset Customized Items | 121 |
| 7-3 | Preset Editing | 122 |
| 7-3-1 | Displaying the Preset Selection List | 128 |
| 7-3-2 | Setting the Present Name | 130 |
| 7-3-3 | Setting the Tcp | 132 |
| 7-3-4 | Setting the Δuv | 134 |
| 7-3-5 | Setting the Tristimulus Value Y | 136 |
| 7-3-6 | Setting the λp | 138 |
| 7-3-7 | Setting the CRI | 140 |
| 7-3-8 | Setting the value of CRI | 142 |
| 7-3-9 | Setting the PPF (Photosynthetic photon flux density) | 144 |
| 7-4 | Dark Calibration | 146 |
| 7-5 | Product Information Display | 149 |
| 7-6 | Regulation Display | 151 |
| 8. | Hardware Setting Screen | 152 |
| 8-1 | Adjust Touch Panel | 154 |
| 8-2 | Edit User Information | 157 |
| 8-3 | Field of View | 159 |
| 8-4 | Factory Setting | 161 |
| 9. | Appendix | 164 |
| 9-1 | Glossary | 164 |
| 9-2 | Specifications | 166 |
| 9-3 | Legal Requirement | 169 |
| 10. | Optional Accessories | 170 |
| 11. | Troubleshooting | 171 |

1. Parts Designations and Functions

1-1 Parts Designations

Front View

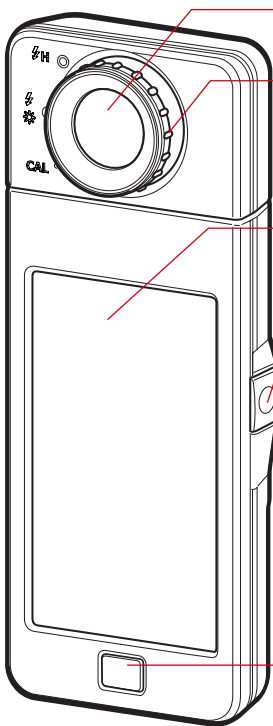

Rear View

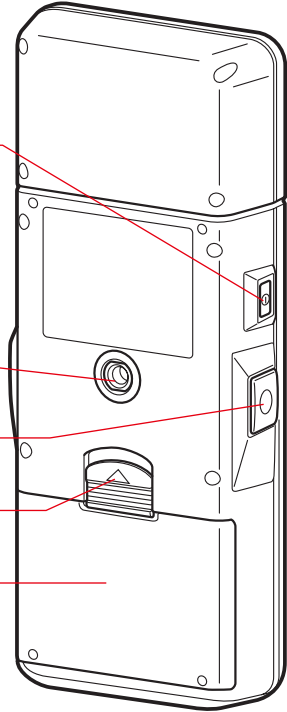

Bottom View

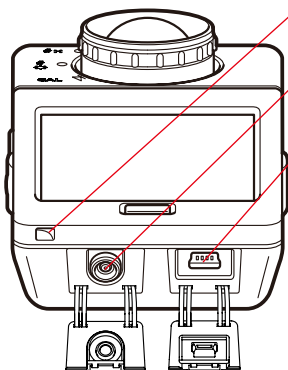

Battery Compartment Section

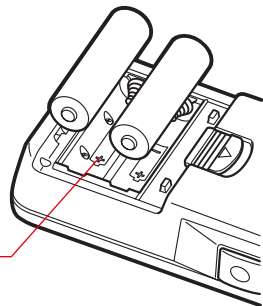

- ① Light Receptor
- ② Light Selection Ring
- ③ Power Button
- ④ Display Panel
- ⑤ Measuring Button
- ⑩ Tripod Socket
- ⑦ Memory Button
- ⑧ Battery Cover Latch
- ⑨ Battery Cover
- ⑥ Menu Button

- ⑬ Strap Eyelet
- ⑫ Sync Terminal
- ⑪ USB Connector
- ⑭ Battery Compartment

1-2 Parts Functions

The following table lists the functions of each part.

| No. | Part Name | Functions |
|-----|-----------------------------|--|
| 1 | Light Receptor | Point light receptor directly at light source during reading. Head rotates 270 degrees to aid reading. |
| 2 | Light Selection Ring | Rotate to select dark calibration, normal measuring range or high range for flash light. |
| 3 | Power Button | Press to turn ON/OFF. |
| 4 | Display Panel | Displays the setting screens and measurement screens. The built-in touch panel function enables setting, selection or operation by touching the displayed screens. (➡ P18) |
| 5 | Measuring Button | Press for measurement. |
| 6 | Menu Button | Press to shift display to Display Mode Selection screen. |
| 7 | Memory Button | Press after measuring to record the measured data. |
| 8 | Battery Cover Latch | Latch for the battery cover. |
| 9 | Battery Cover | Secures the batteries. |
| 10 | Tripod Socket | Female mounting threads (1/4-20) for hands free mounting on tripods. |
| 11 | USB Connector | The USB connector for connecting to the PC with the installed application and USB bus power. USB terminal: Mini-B-5pin |
| 12 | Sync Terminal | Accepts an optional synchro cord when using meter in Cord (PC) Flash Mode. |
| 13 | Strap Eyelet | Used to attach the included strap. |
| 14 | Battery Compartment | Holds two AA size batteries. Insert the batteries in the correct direction. |

2. Before Use

2-1 Attaching the Strap

1. Pass the strap (included) through the outer hole of the Strap Eyelet **13**.
2. Pass the opposite end of the strap through the loop at the end of the strap.

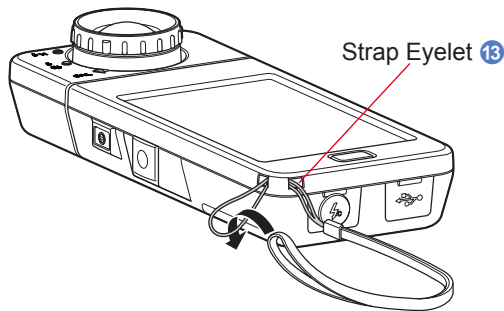

WARNING

Infants or toddlers may accidentally wrap the strap around their neck, so please place it in a location out of their reach. There is a danger of suffocation.

CAUTION

- Infants or toddlers may accidentally grab the strap and swing the product, so please place it in a location out of their reach, as the meter may be damaged by impacts.
- Be careful that the neck strap does not come loose when carrying the product, as the meter may be damaged when dropped.
- This neck strap is made of polyester fiber. Please refrain from using the product if synthetic fibers cause your skin to become irritated, inflamed or itchy in order to prevent worsening your symptoms.

2-2 Installing the Batteries

1. Prepare two AA batteries.
2. Slide the Battery Cover Latch **8** in the direction of the arrow and remove the Battery Cover **9**.
3. Insert the batteries according to the "+" and "-" symbols in the Battery Compartment **14**.

* As shown in the diagram below, please note both positive sides of the batteries are facing in the same direction.

4. While lining up the two tabs on the Battery Cover **9**, press the Battery Cover **9** back into place from above.

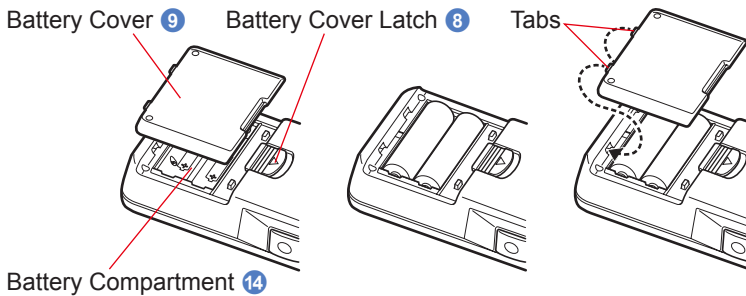

WARNING

Do not place batteries in open flames, attempt to short, disassemble, apply heat to, or recharge them (except rechargeable batteries). They may burst and cause fires, serious injury, or damage to the environment.



CAUTION

- Please insert the batteries minus "-" side first.
When removing the batteries, remove them plus "+" side first.
- Do not use batteries with any other rating than the one specified.
Also, do not mix old and new batteries.
- If the meter will not be used for an extended period of time,
it is recommended to remove the batteries to avoid possible damage caused
by battery leaking.

2-3 Power ON/OFF

Power ON

1. Turn the Light Selection Ring **2** to set to the dark calibration position **CAL** ().
2. Press the Power Button **3**.

The meter will turn on and the Opening screen will be displayed (for 2 seconds).

Light Selection Ring **2**

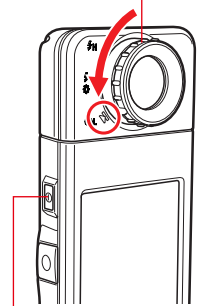

Power Button **3**

C-7000 Opening Screen



NOTICE

- The blue lettered "SEKONIC" logo screen is displayed after battery replacement and 24 hours after power OFF.
- Movement of the blue status bar indicates that the meter is checking its memory and preparing to operate. Do not turn the power OFF. Otherwise, the meter may be damaged.

Logo Screen



3. Dark calibration.

The C-7000 measuring system must be calibrated before use. Turn Light Selection Ring to calibration indication. "Dark calibration in progress. Please wait" and the status bar will appear while calibrating. The Display Mode Selection screen will appear when operational.

Dark Calibration Process Screen

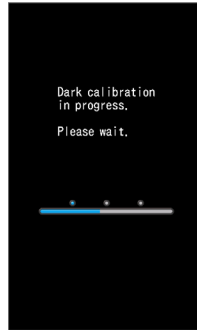

NOTE

Dark calibration is performed when new batteries are used, 24 hours passed since last use or there is a big change in temperature between turning power OFF and ON. Except the cases above, dark calibration after power ON is skipped.

NOTICE

- When the Light Selection Ring ② is not set to the dark calibration position, the message "Please set Light Selection Ring for dark calibration." is displayed. Set the Light Selection Ring ② to the dark calibration position **CAL** () to calibrate the system.

Dark Calibration Position Confirmation Screen

- If dark calibration is not successful, "Dark calibration failed. Please check Light Selection Ring position." is displayed. Set the Light Selection Ring ② to the dark calibration position **CAL** () to calibrate the system.

Dark Calibration Confirmation Screen

4. Touch the icon to be displayed on the Display Mode Selection screen.

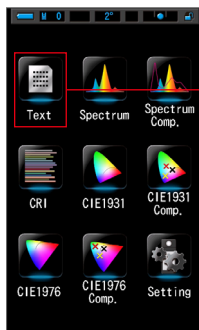

The display will switch to the selected measurement screen.

Display Mode Selection Screen

Measuring Screen

5. Press the Measuring Button ⑤ to measure.

Turn the Light Selection Ring ② to select the range.

When measuring ambient light, make sure to select Range L ().

When measuring flash units, select Range L () or Range H () depending on the brightness of the flash. (→ P77, → P78)

NOTICE

When the Measuring Button ⑤ is pressed at the dark calibration position, the message "Measurement failed. Please check Light Selection Ring position." is displayed. Turn the Light Selection Ring ② to select the range.



NOTE

Measurement and display will take longer in light levels below 30lx. The LCD illumination will normally switch off during measurement to avoid influence to measurement.

Power OFF

1. Press and hold the Power Button ③ for 1 second or longer.

The meter will turn OFF.

NOTICE

Please wait 3 seconds between repeated power on and power off sessions.

NOTE

- If the LCD screen shows no display, check if the batteries are installed properly (Pos/Neg positioning) and have enough capacity.
- All settings and measurements made during use are saved in memory even after the meter is powered off.

2-4 Checking the Battery Capacity

When the power is turned ON, the LCD screen will show the battery capacity indicator.



Sufficient battery life remaining.



Adequate battery life remaining.



Have a spare battery ready.



Replace the battery immediately.

Battery capacity indicator

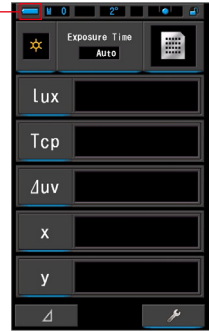

NOTE

- When battery power is low and the meter is turned ON, the LCD screen will appear and then turn off immediately. This is an indication that the batteries are depleted and should be replaced immediately.
Having spare batteries on hand is recommended.
- When the meter is continuously used at room temperature, the battery life should last 8 hours (based on Sekonic testing methods).

2-5 Automatic Power OFF Function

To save battery capacity, the meter will automatically turn off 5 minutes (factory setting) after the last button is pressed.

NOTE

- All measurements, settings and indications are saved in memory even after the meter has automatically turned off. When the power is turned ON, they will be displayed again.
- The automatic power off time setting can be selected according to your needs in the settings. (► P115)
- If, while in transport, the Power Button ③ is inadvertently and continually pressed in, the meter will turn ON for about 1 minute and then turn automatically turn OFF to save battery power.

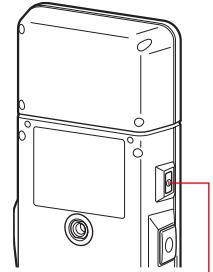

Power Button ③

2-6**Changing Batteries During Measurement**

- Please make sure the power is OFF when replacing batteries. If left ON, the meter circuit could be damaged and measurements taken during the last operation will not be saved.
- If an unexpected display appears on the LCD during battery replacement or measurement, ie. settings other than selected, or if the meter does not respond when a button is pressed, remove the batteries, wait at least 10 seconds, and then re-install them.

3. Basic Operation Methods

3-1 Basic Operation Flow

The basic operations and screens are as follows. Measurements and measurement changes are operated from the Measurement screen.

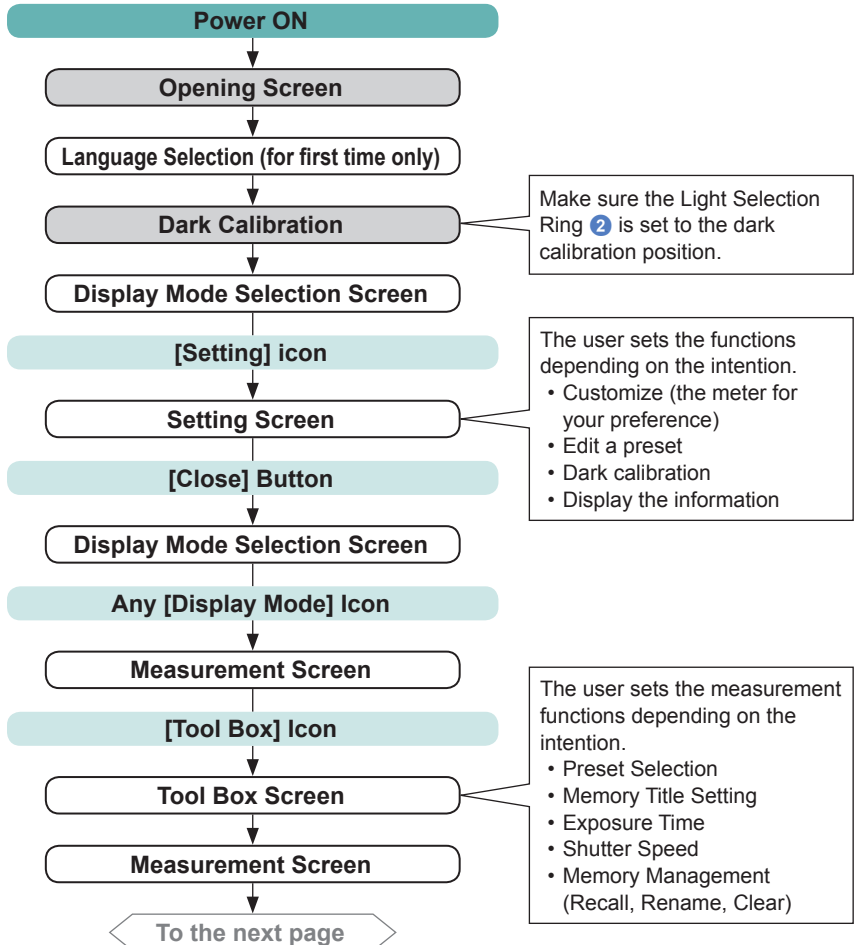

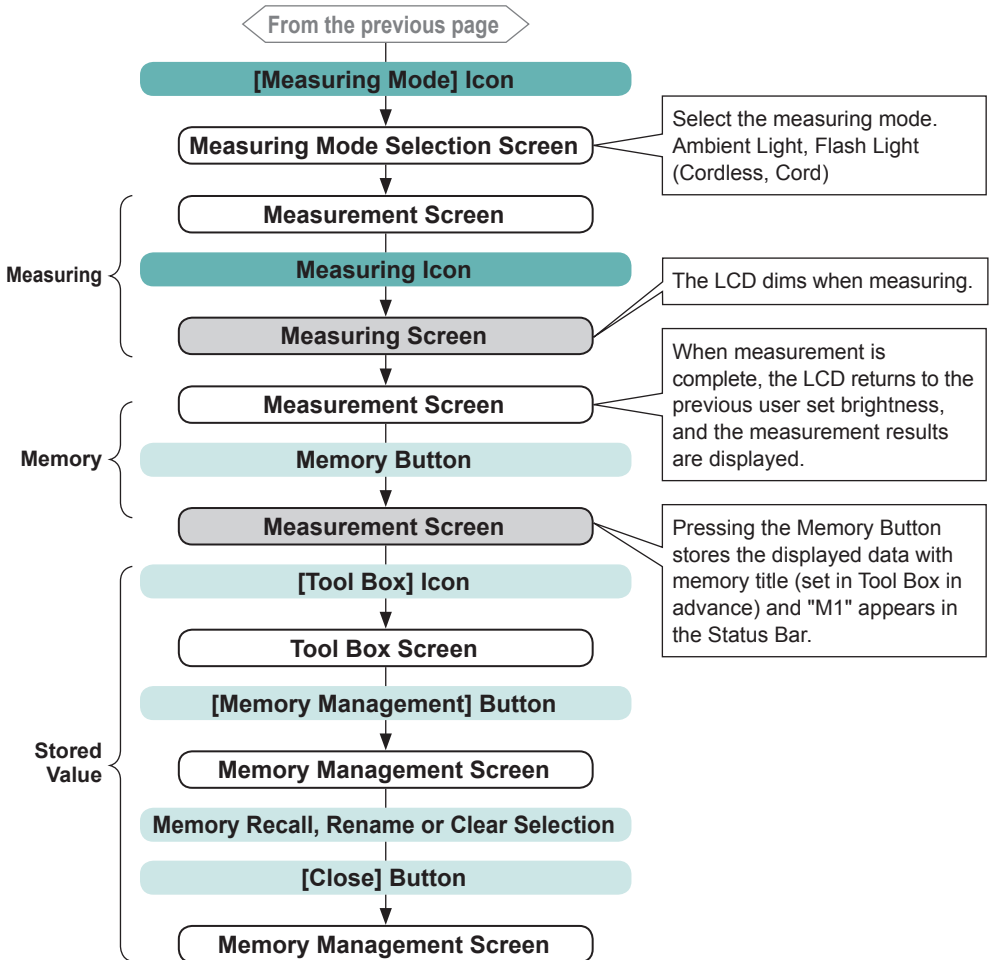

3-2 Screen and Operation

3-2-1 Basic Screen and Operation

The touch-screen display enables selecting Display Modes and settings with the touch of your finger.

Measurement Screen

The Measurement screen is displayed (for 2 seconds) after the power is turned ON, and the dark calibration is made.

When the dark calibration is complete, the Display Mode Selection screen is displayed. Select the desired display mode and the selected measurement screen is displayed. Press the Measuring Button to make a measurement after setting the measuring mode (ambient or flash light) and relevant settings in Tool Box.

* Pressing the Menu Button **6** returns the meter to the Display Mode Selection screen.

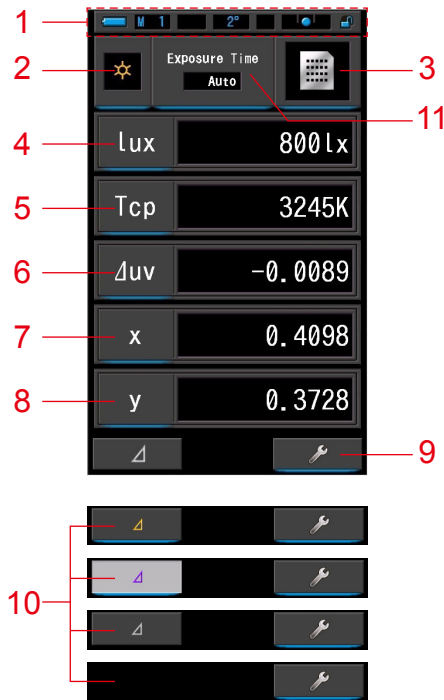

Measuring Screen in Text Mode



* The display changes depending on the set measuring mode.

* For this description, all icons and menus are displayed.

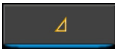
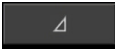
Item List

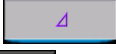
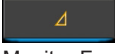
| No. | Part Name | Description |
|-------|--|--|
| 1 | Status Bar | Displays the setting contents. (➔ P16) |
| 2 | [Measuring Mode] Icon | Displays the measuring mode. (➔ P22) Switches to the Measuring Mode Selection screen. |
| 3 | [Display Mode] Icon | Displays the display mode. (➔ P28) Switches to the Display Mode Selection screen. |
| 4 ~ 8 | [Display Item] Indication | Switches to the Item Selection screen. (➔ P27) |
| 9 | [Tool Box] Icon | Switches to the Tool Box screen. (➔ P79) |
| 10 | [Delta] Icon (in Ambient Light Mode only) |  Displays when Monitor Function can be performed. |
| | |  When there is no reference preset value, the icon is disabled. |
| | |  When Monitor Function cannot be performed, the (Δ) icon is not displayed. |
| | | When  is touched, Monitor Function is activated. The preset value is shown in yellow letter when this delta icon is displayed. When holding the Measuring Button 5 , the value differences of the preset value and the current reading being measured will be displayed. (The preset value is a value that has been preset.) When the Measuring Button 5 is released, the display will revert to the preset value. When  is touched, the icon returns to  and the values measured last are displayed. Monitor Function is cancelled when the power is turned OFF. Note: When the Monitor Function icon is displayed, the Memory Button 7 is disabled. |
| 11 | [Exposure Time] Indication | Switches to the Exposure Time Selection screen. (➔ P24) |















 **NOTE**

When values are outside the display or measurement range, [Under] or [Over] is displayed.
 Under: Displayed if value is lower than measurement range (too dark) or color temperature value is too low.
 Over: Displayed if value is higher than measurement range (too bright) or color temperature value is too high.

Status Bar



* For this description, all icons and menus are displayed.

| No. | Part Name | Description | |
|-----|---------------------------------------|---|---|
| 1 | Battery Capacity Indicator |  | Sufficient battery life remaining. |
| | |  | Adequate battery life remaining. |
| | |  | Have a spare battery ready. |
| | |  | Replace the battery immediately. |
| | |  | Appears when powered by USB. |
| 2 | Memory Count |  | Displays the number of measured data stored in memory. The number in memory is displayed until 999 to the right of the mark. |
| 3 | Preset Selection |  | Displays the preset number when a preset is selected. |
| 4 | Field of view |  | Displays the viewing angle (2° or 10°) that was set when hardware was set. |
| | |  | |
| 5 | Temperature Fluctuation Warning |  | When the mark appears, the temperature is fluctuating, and accurate measurement may not be possible. Please perform dark calibration. |
| 6 | Light Selection Ring Status Indicator |  | Appears when the Light Selection Ring ② is selected by the dark calibration position. |
| | |  | Appears when the Light Selection Ring ② has range "L" selected. |
| | |  | Appears when the Light Selection Ring ② has range "H" selected. |
| 7 | Key Lock Status Indicator |  | Appears when the screen is unlocked. |
| | |  | Appears when the screen is locked. When the screen is locked, touch panel operations are disabled. |

Tool Box Screen

The following setting can be performed after touching the [Tool Box ()] icon on the measuring screen.

* All icons are displayed for explanatory purposes for the Tool Box screen. It is not the default.

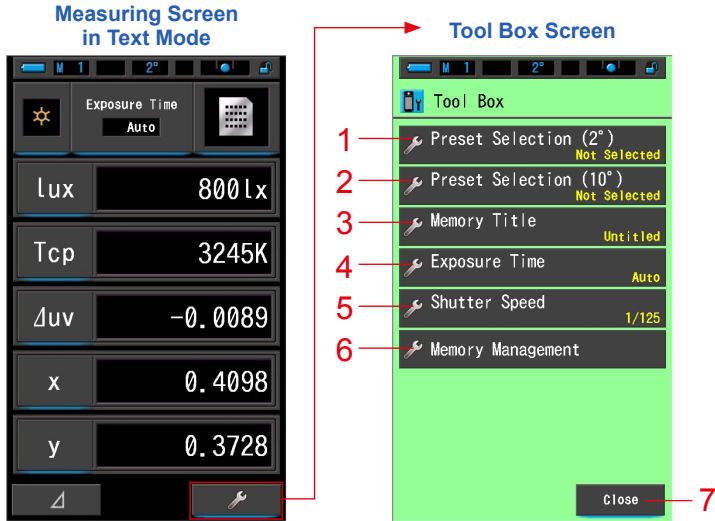

[Tool Box: Item List]

| No. | Part Name | Description |
|-----|-------------------------------|---|
| 1 | Preset Selection (2°) | Switches to the Preset Selection screen. (➡ P80) |
| 2 | Preset Selection (10°) | Switches to the Preset Selection screen. (➡ P80) |
| 3 | Memory Title | Switches to the Memory Title Input screen. (➡ P84) |
| 4 | Exposure Time | Switches to the Exposure Time screen. (➡ P101) |
| 5 | Shutter Speed | Switches to the Shutter Speed screen. (➡ P103) |
| 6 | Memory Management | Switches to the Memory Management screen. (➡ P88) |
| 7 | [Close] Button | Closes the Tool Box screen and returns to the Measurement screen. |

3-2-2 Icon Operation

Touch Operation

Touch the icons on screen to perform various operations.

(Ex.) Measuring Screen in Text Mode



Touch-enabled Icons

A blue illumination under icons indicates which icons are operational.

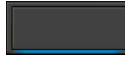

Touch-enabled Icons



Touch-disabled Icons

Slide Operation

Slide your finger tip up or down over a value to change the value amount. Sliding your finger over scroll bar provides fast navigation of large menus.

(Ex.) Shutter Speed Selection Screen

Scroll Selection

Slide a finger up or down on the setting value areas to change setting values.

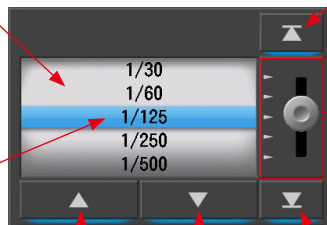

Top Icon

Touch to advance to the lowest value.

Scroll Bar

Touch and slide up or down to scroll settings.

One Step Icon

Touch the Up or Down icon to advance one position.

Bottom Icon

Touch to advance to the highest value.

* Blue bar indicates the value selected.

3-2-3 Input of Numbers/Characters

You can input numbers and characters.

Numeric Number Input Screen

(Ex.) Display of deviation Δuv

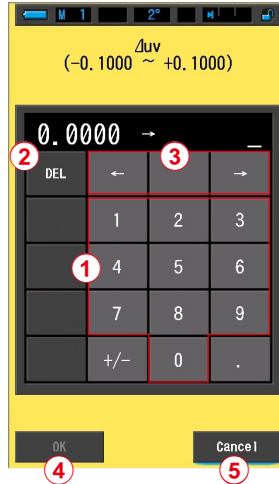

Numeric Number Method

| No. | Key | Description |
|-----|-------------------------|--|
| ① | 0-9, +/-, period | Enters a numeric value, plus or minus sign, and a period. When touched, the entry is displayed at the top of the screen. |
| ② | Delete | Deletes input value at cursor position. |
| ③ | ← → | Moves input position. |
| ④ | OK | Confirms input value and returns to previous screen. |
| ⑤ | Cancel | Cancels input value and returns to previous screen. |

Character Input Screen

Figure Input Screen

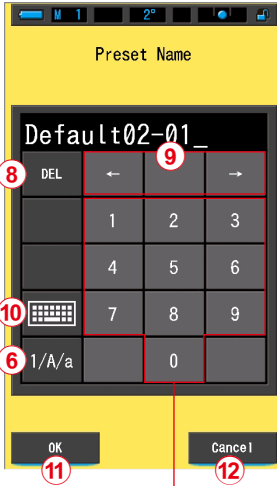

⑦ (Figures)

Upper Case Input Screen

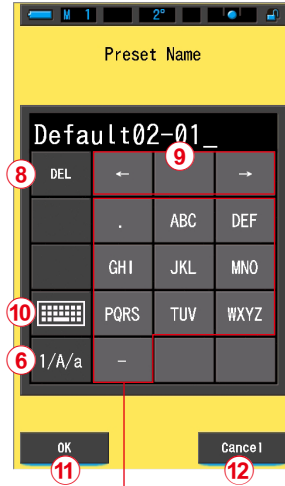

⑦ (Upper Case Letters)

Lower Case Input Screen

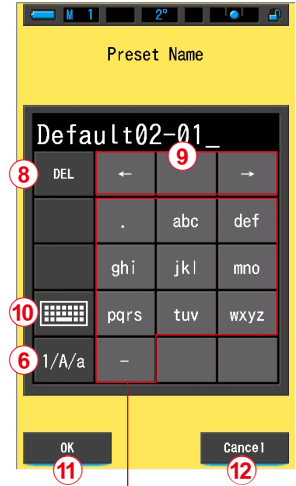

⑦ (Lower Case Letters)

Keypad (Upper Case Input Screen)

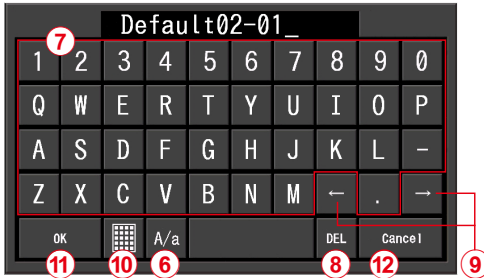

Keypad (Lower Case Input Screen)

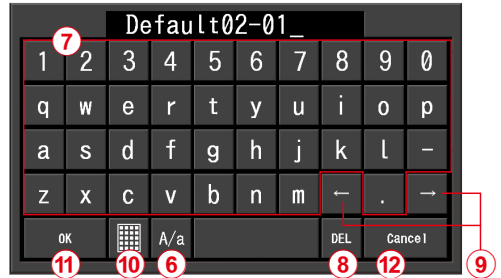

Input Method of Characters and Numbers

| No. | Key | Description |
|-----|-------------------------------|--|
| ⑥ | 1/A/a | Shifts between numbers/upper case letters/lower case letters. |
| ⑦ | 0-9, ABC, abc, hyphen, period | Value displayed on screen when key touched. Repeated touching of the same button for alphabet (ABC/abc) will change the alphabet character in order. |
| ⑧ | Delete | Deletes the character at the cursored position. |
| ⑨ | ← → | Moves input position. |
| ⑩ | Keypad | Shifts between Standard Keypad and Qwerty Keypad. |
| ⑪ | OK | Confirms input value and returns to previous screen. |
| ⑫ | Cancel | Cancels inputting and returns to previous screen. |

3-2-4 Locking and Unlocking the Screen

You can lock the screen to prevent misoperation.

When the screen is locked, touch operation is disabled.

However, the Memory Button **7**, Measuring Button **5**, and Power Button **3** are still operational.

The screen will stay locked even when power is turned OFF and ON.

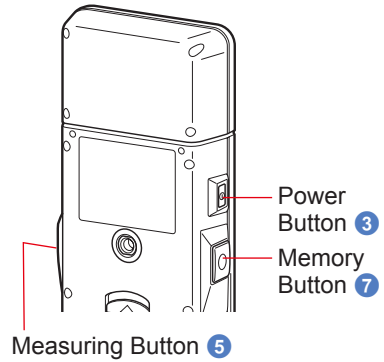

To Lock

In any measuring mode, press and hold the Menu Button **6** to see the Locked icon [] appear at the upper right corner of the LCD screen.

Function Icons cannot be operated while the screen is locked.



The Locked icon [] will appear for approximately 1 second at the center of the screen when function icons are touched or MENU button **6** is pressed.

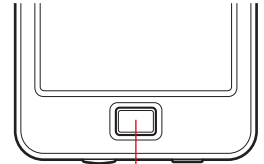

Menu Button **6**

To Unlock

Press and hold the MENU Button **6** to see Unlocked icon [] appear at the top of the LCD screen.

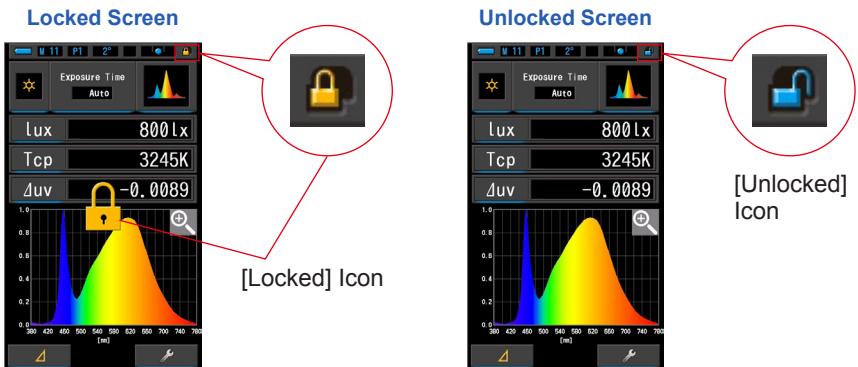

4. Setting the Measuring Conditions

4-1 Selecting the Measuring Mode

4-1-1 Matching Measuring Mode with Light Sources



Select the Measuring Mode to use.

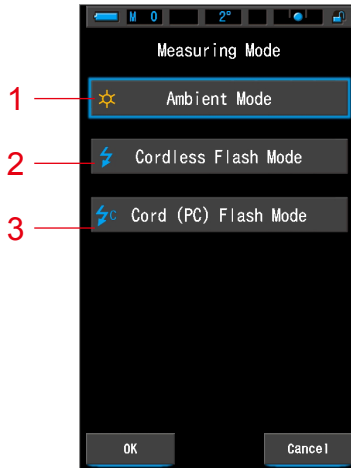

When changing the measuring mode setting, the measurement data will be erased.

Measuring Mode Selection Screen



| No. | Measuring Mode | Icon | Description |
|-----|----------------------|---|---|
| 1 | Ambient Light Mode |  | Measures continuous light such as sunlight, tungsten, fluorescent, and LED lights. (➔ P61) |
| 2 | Cordless Flash Mode |  | Detects flash color temperature without meter-flash connection after Measuring Button pressed to arm meter (for 90 seconds) and flash fired separately. Measure using a flash during the wait time. (➔ P65) |
| 3 | Cord (PC) Flash Mode |  | Detects flash color temperature with PC (synchro) cord meter-flash connection. (➔ P69) |

Operation

1. Touch the [Measuring Mode] icon in the upper left corner of the screen.
The Measuring Mode Selection screen will be displayed.

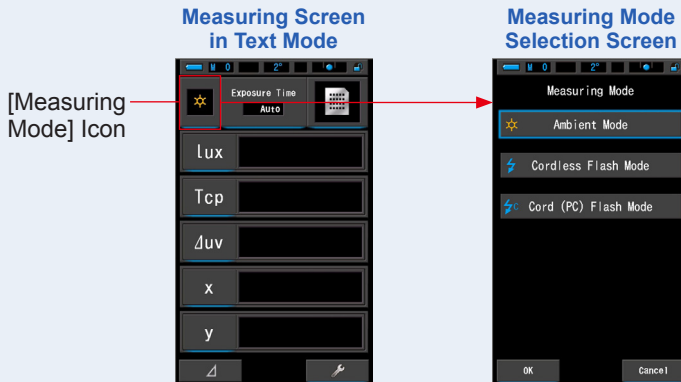

2. Touch an icon to select the measuring mode.

Select the desired measuring mode.

3. Touch the [OK] button.

Confirms the settings, and returns to the previous Measurement screen.

Touch [Cancel] to return to the previous measurement screen without setting.

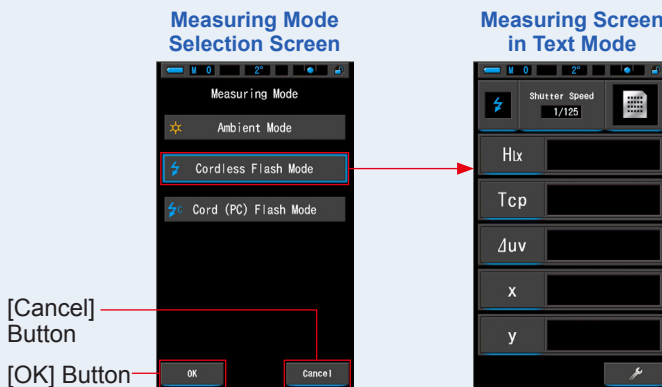

Ex.) Ambient Light Mode→Cordless Mode



NOTE

- Ambient light includes continuous light sources such as natural light (sunlight), tungsten lamps, fluorescent lamps, LED lights, etc.
- Flash light includes brief and intense burst of light sources such as electronic flash units or flash bulbs.

4-1-2

Selecting the Exposure Time (Ambient Modes Only)

Set a Exposure Time for ambient measurement.

Operation

1. Touch the [Exposure Time] indication on the Measurement screen.
Touch the [Auto], [0.1 sec] or [1.0 sec] button.

Measuring Screen

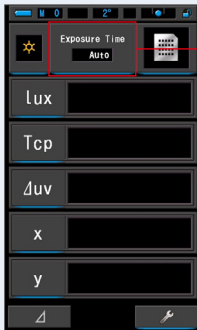

Exposure Time Screen

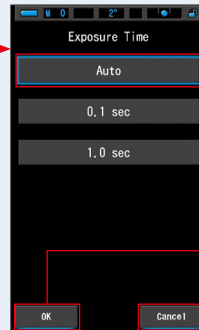

The selected button will be displayed encircled in blue.

[OK] Button

[Cancel] Button

2. Touch the [OK] button.

Confirms the settings, and returns to the previous Measurement screen.

Touch [Cancel] to return to the previous measurement screen without setting.

Exposure time is set.

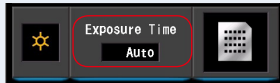

NOTE

In Auto mode, the C-7000 automatically selects among 15 measuring times, determined by the illumination available, to achieve a proper result in a convenient way. Two fixed reading times are available to enable exact comparison of multiple measurements.

When measuring high illuminance levels, set the Exposure Time to 0.1 sec.

When taking measurements in low illuminance, set the Exposure time for 1.0 sec.



NOTICE

0.1 sec and 1.0 sec may not cover some measurement range of illumination and [OVER] or [UNDER] appears. In this case, set Exposure time to "Auto".

4-1-3 Selecting the Shutter Speed (Flash Modes Only)

Set a shutter speed that is appropriate for the intended flash-ambient measurement.

Operation

1. Touch the [Shutter Speed] indication.

Measuring Screen in Text Mode

Text Mode in
Cordless Mode

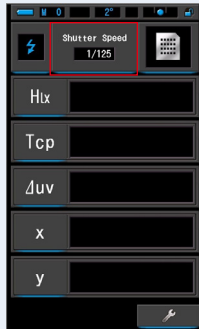

2. Select the desired shutter speed.

Shutter Speed Screen

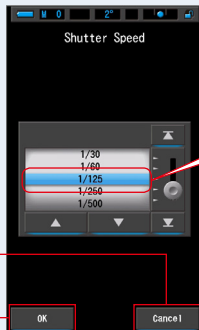

[Cancel]
Button

[OK] Button

[Shutter Speed 1/125]

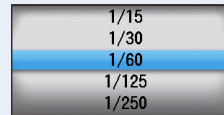
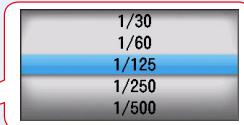

[Shutter Speed 1/60]

3. Touch the [OK] button.

Confirms the settings, and returns to the previous Measurement screen.

Touch [Cancel] to return to the previous measurement screen without setting speed.

The shutter speed is set.



**NOTE****Shutter Speed Options**

| 1 Step |
|--------|
| 1s |
| 1/2 |
| 1/4 |
| 1/8 |
| 1/15 |
| 1/30 |
| 1/60 |
| 1/125 |
| 1/250 |
| 1/500 |

**NOTICE**

- When measuring flash-light color in high ambient light conditions (580 lx-s or higher), select a shutter speed of 1/250 or 1/500 sec to reduce or eliminate the influence of the ambient light in the measurement. Using slower shutter speeds will include ambient light color in the measurement.
- Measuring data will be erased when the shutter speed setting is changed.

4-2

Customizing Measuring Displays

The meter's display can be customized to show only items you need in a single view.

Operation

1. Touch the [Display Item] indication on the Measurement screen.
The Display item library screen will be displayed. (→ P33)
2. Select the items to be displayed.
Selected items and the values will be displayed.

Measuring Screen
Text Display

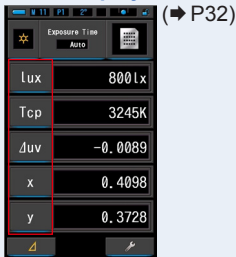

Measuring Screen
Spectrum Display

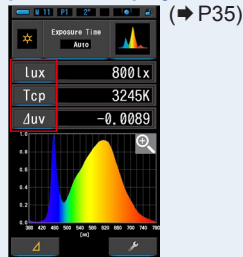

Measuring Screen
CRI Display

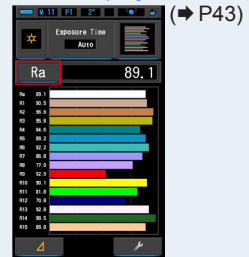

Display Item List

| Field of view No. | 2° 10° | | Name | Description |
|-------------------|-------------------|------------------|------------------------------------|---|
| | Icon | | | |
| 1 | T_{cp} | | Correlated Color temperature | Displays the color temperature. |
| 2 | Δuv | | Deviation | Displays a deviation from the black body radiation. |
| 3 | X | X_{10} | Tristimulus value | Displays tristimulus value X or X_{10} . |
| 4 | Y | Y_{10} | | Displays tristimulus value Y or Y_{10} . |
| 5 | Z | Z_{10} | | Displays tristimulus value Z or Z_{10} . |
| 6 | x | x_{10} | Chromaticity coordinates | Displays CIE1931 chromaticity coordinates x, or CIE1964 chromaticity coordinates x_{10} . |
| 7 | y | y_{10} | | Displays CIE1931 chromaticity coordinates y, or CIE1964 chromaticity coordinates y_{10} . |
| 8 | z | z_{10} | | Displays CIE1931 chromaticity coordinates z, or CIE1964 chromaticity coordinates z_{10} . |
| 9 | u' | u'_{10} | | Displays CIE1976 chromaticity coordinates u' or u'_{10} . |
| 10 | v' | v'_{10} | | Displays CIE1976 chromaticity coordinates v' or v'_{10} . |
| 11 | λd | λd_{10} | | Dominant wavelength |
| 12 | P_e | $P_{e,10}$ | Excitation purity | Displays the excitation purity. |
| 13 | λp | | Peak wavelength | Displays the peak wavelength. |
| 14 | lux | H_{lx} | Illuminance / luminous exposure | Displays the illuminance or luminous exposure. It can be set on this spectrometer. |
| 15 | fc | H_{fc} | | |
| 16 | R_a | | Average Color Rendering Index | Displays the average CRI of R1 to R8. |
| 17 | R_1 to R_{15} | | Special Color Rendering Index | Displays the CRI of R1 to R15. |
| 18 | $PPFD$ | | Photosynthetic photon flux density | Displays the PPFD. |

* Models sold in some countries do not display illuminance and exposure in "fc (fc·s)" due to legal restrictions.

4-3 Selecting the Display Mode

Touching an icon on the Display Mode Selection screen displays lighting information in different ways to suit your needs.

* Pressing the Menu Button **6** returns the screen to the Display Mode Selection.

Display Mode Selection Screen (2°)



Display Mode Selection Screen (10°)



1 Text

2 Spectrum

3 Spectrum Comparison

4 CRI

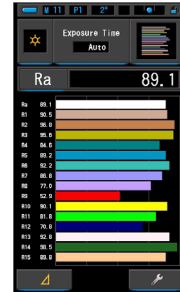
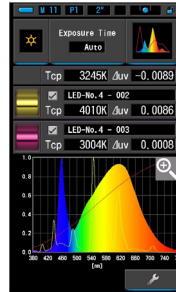
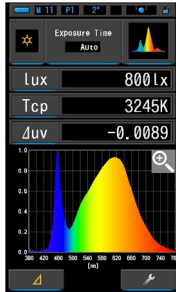

5 CIE1931 (CIE1964)

6 CIE1931 (CIE1964) Comparison







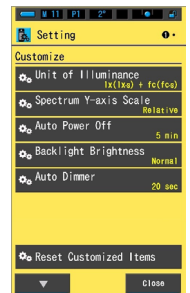
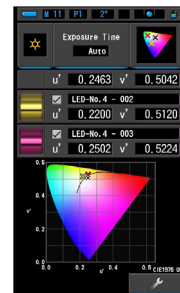
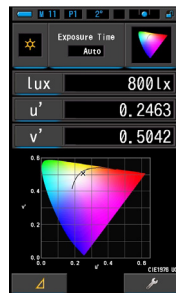
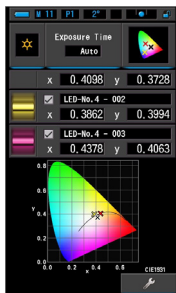
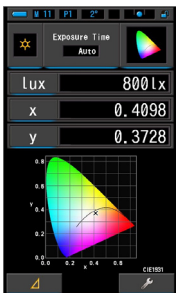

7 CIE1976

8 CIE1976 Comparison

9 Setting



Display Mode Icons List

| No. | Icon | Display Mode Name | Description |
|-----|---|-------------------------------------|--|
| 1 |  | [Text] Icon | Displays user-selected 5 items in numeric values. (➔ P32) |
| 2 |  | [Spectrum] Icon | Displays 3 user-selected values and spectrum distribution graph. (➔ P35) |
| 3 |  | [Spectrum Comparison] Icon | Compares the current measurement value and up to 2 memorized values in the spectrum distribution graph. (➔ P38) |
| 4 |  | [CRI] Icon | Displays the selected average CRI (Ra) or individual CRI (R1 ~ R15) numerically. Each CRI is displayed in a bar graph. (➔ P43) |
| 5 |  | [CIE1931 (CIE1964)] Icon | Displays the preset data together with the CIE1931 chromaticity diagram (or CIE1964 chromaticity diagram for a 10° viewing angle). (➔ P46) |
| 6 |  | [CIE1931 (CIE1964) Comparison] Icon | Displays the preset data and the stored measurement value (up to 2 types of data) together with the x and y coordinates in the CIE1931 chromaticity diagram (or CIE1964 chromaticity diagram for a 10° viewing angle). (➔ P48) |
| 7 |  | [CIE1976] Icon | Displays the measurement result together with the CIE1976 chromaticity diagram. (➔ P52) |
| 8 |  | [CIE1976 Comparison] Icon | Displays the measured result and the stored measurement value (up to 2 types of data) together with the u' and v' coordinates on the CIE1976 chromaticity diagram. (➔ P54) |
| 9 |  | [Setting] Icon | Displays Setting screen. (➔ P58) |

* 1 ~ 8 are the Measurement screen.

Operation

1. Touch the [Display Mode] icon on the Measurement screen or press Menu Button **6** on the meter.

The Display Mode Selection screen will be displayed. (⇒ P28)

Display modes from No.1 to 8 are for measurement.

Display mode No.9 is for settings.

2. Touch a desired Display Icon.

The measurement screen in selected Display Mode appears on the screen.

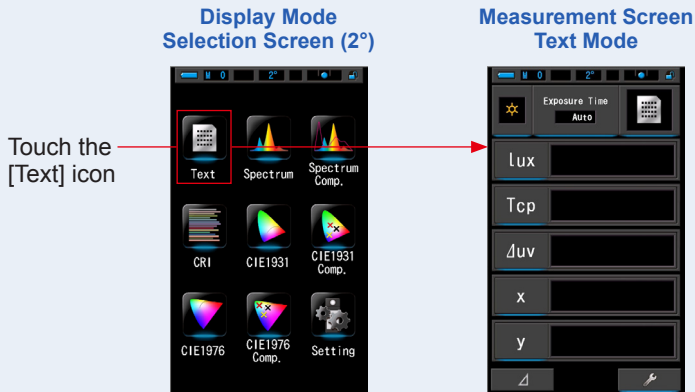



3. Touch the [Exposure Time] indication in the Measurement screen.

Set the exposure time to Auto, 0.1 sec, or 1.0 sec during ambient light measurement. (⇒ P24)

4. Press the Measuring Button 5 to measure.

The Light Selection Ring 2 should be set to L () when taking ambient light measurements.

When measuring flash units, select Range L () or Range H () depending on the brightness of the flash. (→ P77, → P78)

Measurements can now be made.

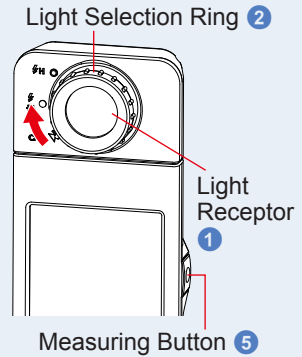

NOTE

- To measure the color temperature of a light source properly, point Light Receptor 1 directly at light source during reading.
- Measurement and display will take longer in light levels below 30lx. The LCD illumination will normally switch off during measurement to avoid influence to measurement.

5. Observe measurement values on Text Mode.

Measurement Screen Text Mode



Measurement result

6. Memorize the measurement results.

Measurement results can be memorized.

To record measurements, press Memory Button 7. (→ P83)

4-3-1 Displaying in Text [Text] Mode

You can select 5 items to display on the Text Screen.

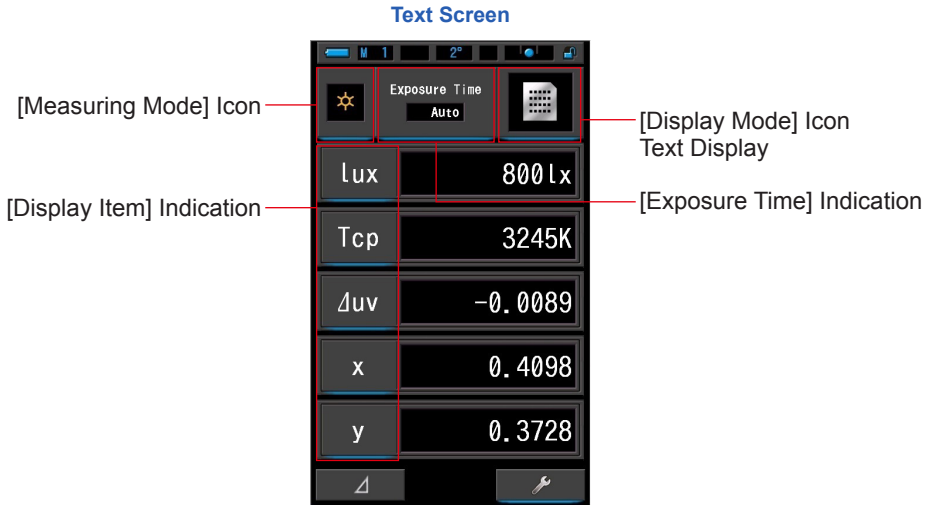

Operation

1. Touch the [Text] icon on the Display Mode screen.

The Text screen will be displayed. (→ P28)

2. Touch the [Measuring Mode] icon.

The Measuring Mode Selection screen will be displayed. Select the desired measuring mode to use. (→ P22)

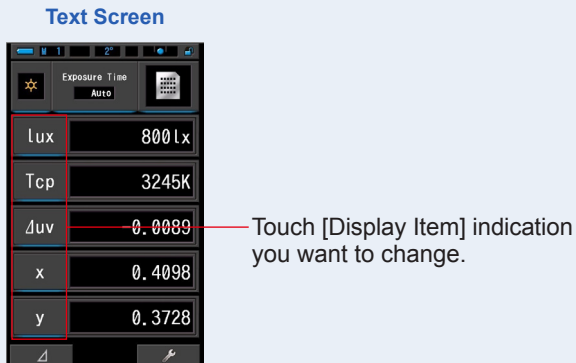

3. Touch the [Display Item] indication to change.

The Display item library screen will be displayed.

The currently selected display item will be encircled in blue.

4. Touch the desired Display Item indication and [OK] button.

Confirms the settings, and returns to the Text screen.

To return to the Text screen without changing, touch the [Cancel] button.

Display Item Library

In Ambient Light Mode Page 1

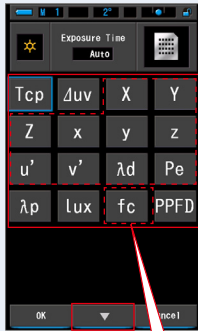

When "fc" is selected

fc

In Flash Mode Page 1

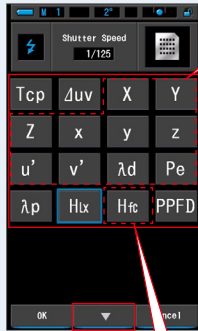

When "fc-s" is selected

Hfc

For a 10° viewing angle

| | | | |
|------------------|------------------|------------------|------------------|
| | X ₁₀ | Y ₁₀ | |
| Z ₁₀ | X ₁₀ | y ₁₀ | Z ₁₀ |
| u' ₁₀ | v' ₁₀ | λd ₁₀ | Pe ₁₀ |

In Both Modes Page 2

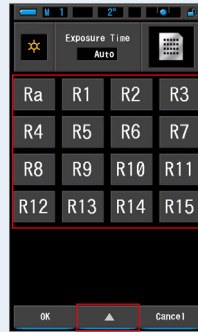

To page 2

To page 1

Touch the desired Display Item.

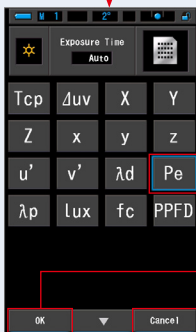

Indication will be encircled in blue.

[OK] Button

[Cancel] Button



New Display Item appears.



* Models sold in some countries do not display "fc (fc-s)" due to legal restrictions.

5. Touch the [Exposure Time] indication in the Measurement screen.

Set the exposure time to Auto, 0.1 sec, or 1.0 sec during ambient light measurement. (→ P24)

6. Press the Measuring Button 5 to measure.

The Light Selection Ring 2 should be set to L () when taking ambient light measurements.

When measuring flash units, select Range L () or Range H () depending on the brightness of the flash. (→ P77, → P78)

Measurements can now be made.

Light Selection Ring 2

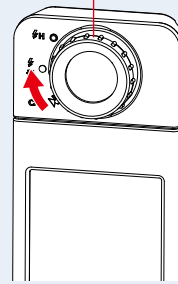

Measuring Button 5



NOTE

Measurement and display will take longer in light levels below 30lx. The LCD illumination will normally switch off during measurement to avoid influence to measurement.

7. Memorize the measurement results.

Measurement results can be memorized.

To record measurements, press Memory Button 7. (→ P83)

4-3-2 Displaying in Spectrum Graph [Spectrum] Mode

Displays three user-selected values and spectral distribution graph.

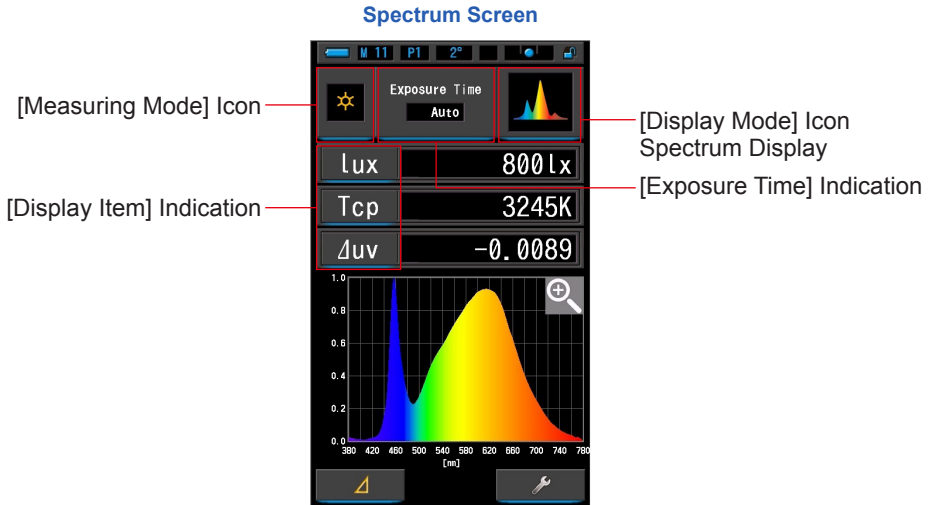



Operation

1. Touch the [Spectrum] icon on the Display Mode screen.
A spectrum distribution graph screen will be displayed. (⇒ P28)
2. Touch the [Measuring Mode] icon.
The Measuring Mode Selection screen will be displayed. Select the desired measuring mode to use. (⇒ P22)
3. Touch the [Display Item] indication to change.
The Display item library screen will be displayed. (⇒ P33)
Touch the desired Display Item and [OK] button.
4. Touch the [Exposure Time] indication in the Measurement screen.
Set the exposure time to Auto, 0.1 sec, or 1.0 sec during ambient light measurement. (⇒ P24)

5. Press the Measuring Button ⑤ to measure.

The Light Selection Ring ② should be set to L () when taking ambient light measurements.

When measuring flash units, select Range L () or Range H () depending on the brightness of the flash. (➔ P77, ➔ P78)

Measurements can now be made.

Light Selection Ring ②

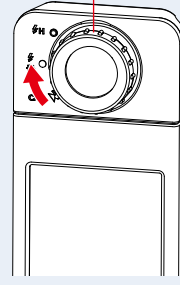

Measuring Button ⑤



NOTE

Measurement and display will take longer in light levels below 30lx. The LCD illumination will normally switch off during measurement to avoid influence to measurement.

6. Touch the [Magnifying Glass (+)] icon on the screen.

The spectrum distribution graph will be enlarged.

The enlarged graph is displayed on the whole screen (landscape).

To return to the Spectrum screen, touch the [Magnifying Glass (-)] icon on the enlarged spectrum distribution graph.

Spectrum Screen

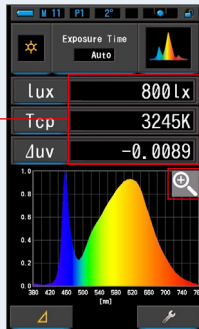

Measurement results are displayed.

Spectrum Distribution Graph Enlarged Display

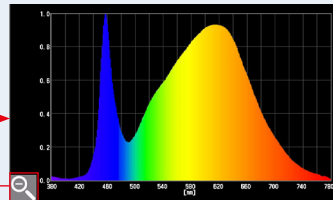

NOTICE

When the enlarged graph is displayed, measurement cannot be performed.

**NOTE**

The maximum display value of the Y-axis can be selected by the item [Spectrum Y-axis Scale] icon in page 1 of Setting. (➔ P112)

7. Memorize the measurement results.

Measurement results can be memorized.

To record measurements, press Memory Button **7**. (➔ P83)

4-3-3

Displaying in Spectrum Comparison [Spectrum Comp.] Mode

Displays the current measured value plus up to two selected values from the meter's memory for comparison.

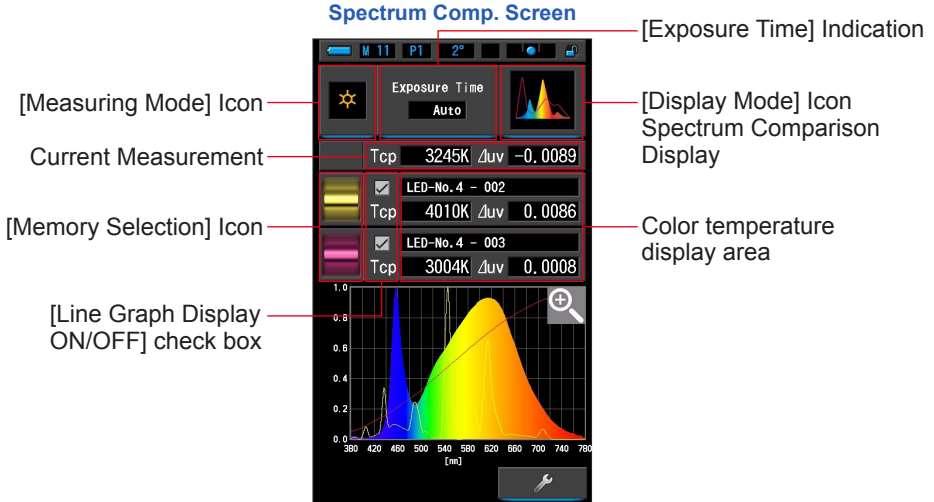



Operation

1. Touch the [Spectrum Comp.] icon on the Display Mode screen.
The Spectrum Comp. screen will be displayed. (⇒ P28)
2. Touch the [Measuring Mode] icon.
The Measuring Mode Selection screen will be displayed. Select the desired measuring mode to use. (⇒ P22)
3. Touch the [Exposure Time] indication in the Measurement screen.
Set the exposure time to Auto, 0.1 sec, or 1.0 sec during ambient light measurement. (⇒ P24)

4. Press the Measuring Button ⑤ to measure.

The Light Selection Ring ② should be set to L () when taking ambient light measurements.

When measuring flash units, select Range L () or Range H () depending on the brightness of the flash. (→ P77, → P78)

Measurements can now be made.

Light Selection Ring ②

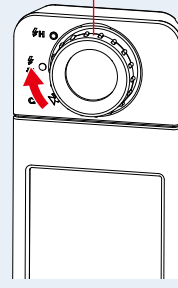

Measuring Button ⑤



NOTE

Measurement and display will take longer in light levels below 30lx. The LCD illumination will normally switch off during measurement to avoid influence to measurement.

5. The current measurement is displayed at the top of display area.

6. Touch the [Memory Selection] icon.

The [Spectrum Comp. Memory] screen will be displayed.

Spectrum Comp.
Screen

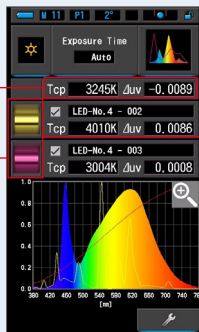

Current Measurement

[Memory Selection] Icon

Spectrum Comp.
Memory Screen

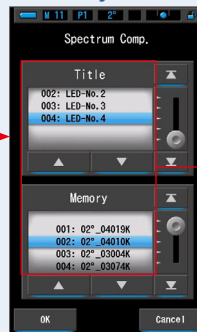

Memory Selection Area

If no measurements have been memorized, a message will be displayed to indicate this pop-up screen.

Memory Selection Pop-up Screen



After you confirmed the message "No memorized value.", touch the [Close] button. Returns to the Spectrum Comp. screen.



NOTE

See the "6-2-1 Naming Measurement Values Being Memorized [Memory Title] Screen" (→ P84) to learn how to memorize measurements.

7. Select the desired memory data to compare the spectrum.

When a title is selected, the memory linked to the title will be displayed. Select a memorized reading for display and comparison.

To select a title and a memory, match them with the blue background positions.

Spectrum Comparison Title/Memory Screen

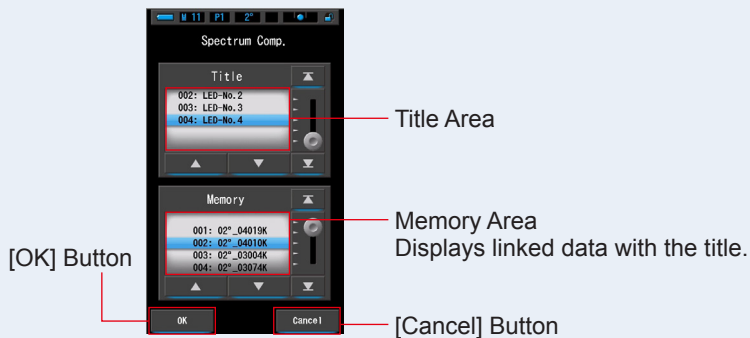

8. Touch the [OK] button.

Confirms the setting and returns to the Spectrum Comp. screen.

To cancel the setting, touch the [Cancel] button.

9. The titles and measurements of the selected memories will be displayed on the Spectrum Comp. screen.

Memory Title Display

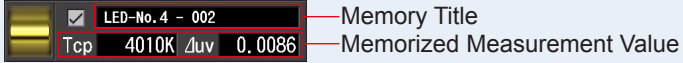

10. Line graphs will be displayed in the spectrum graph.

Touch the [Line Graph Display ON/OFF] to hide/show a line graph on the screen.

* shows line. hides line.

Spectrum Comp. Screen

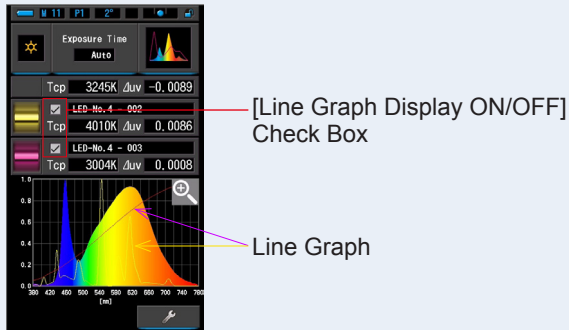

11. Touch the [Magnifying Glass (+)] icon.

The spectrum comparison graph will be enlarged.

The enlarged graph is displayed on the whole screen (landscape).

To return to the Spectrum Comp. screen, touch the [Magnifying Glass (-)] icon on the enlarged spectrum comparison graph.

Spectrum Comp. Screen

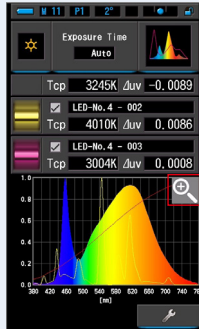

Spectrum Comparison Graph Enlarged Display

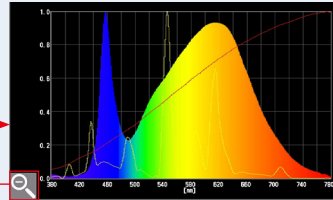

NOTICE

When the enlarged graph is displayed, measurement cannot be performed.

NOTE

- The maximum display value of the Y-axis can be selected by the item [Spectrum Y-axis Scale] icon in page 1 of Setting. (➔ P112)
- During Spectrum Comparison, the Contrast Function is not available and [] button will be hidden.

12. Memorize the measurement results.

Measurement results can be memorized.

To record measurements, press Memory Button . (➔ P83)

4-3-4 Displaying in Color Rendering Index [CRI] Mode

Displays the selected average CRI (Ra) or individual CRI (R1 ~ R15) numerically. Each CRI is also displayed in a bar graph.

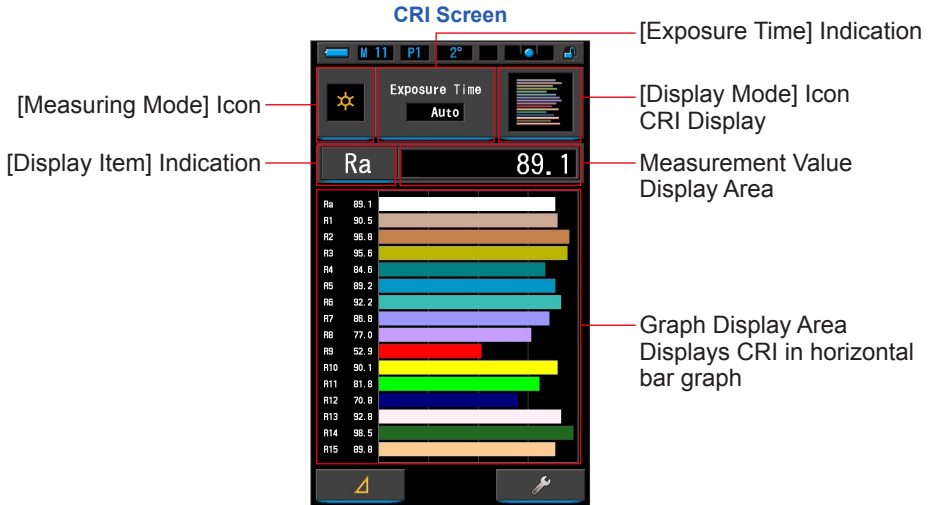



Operation

1. Touch the [CRI] icon on the Display Mode screen.
The CRI screen will be displayed. (→ P28)
2. Touch the [Measuring Mode] icon.
The Measuring Mode Selection screen will be displayed. Select the desired measuring mode to use. (→ P22)
3. Touch the [Exposure Time] indication in the Measurement screen.
Set the exposure time to Auto, 0.1 sec, or 1.0 sec during ambient light measurement. (→ P24)

4. Press the Measuring Button 5 to measure.

The Light Selection Ring 2 should be set to L () when taking ambient light measurements.

When measuring flash units, select Range L () or Range H () depending on the brightness of the flash. (→ P77, → P78)

Measurements can now be made.

Light Selection Ring 2

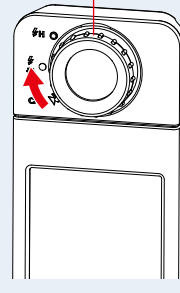

Measuring Button 5



NOTE

- Graph display areas Ra, R1 ~ R15 are always displayed.
- Measurement and display will take longer in light levels below 30lx. The LCD illumination will normally switch off during measurement to avoid influence to measurement.
- Ra is the averaged value from R1 to R8 only. R9 to R15 are not included in the Ra.

5. Touch the [Display Item] indication to change.

The Display item library screen will be displayed.

CRI Screen

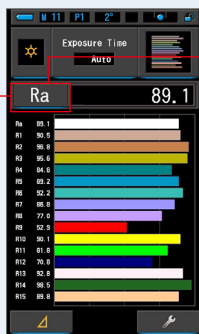

[Display Item]
Indication

Display Item Library

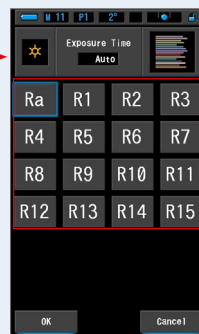

6. Touch the desired Display Item.

Select the item to display above the graph.
Indication will be encircled in blue.

7. Touch the [OK] button.

Returns to the CRI screen by the [OK] button.

Touching the [Cancel] button returns to the CRI screen without the display item being changed.

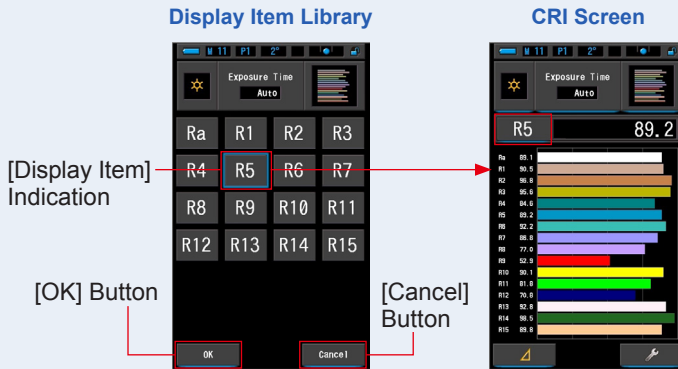

4-3-5 Displaying in CIE1931 (CIE1964) [CIE1931 (CIE1964)] Mode

Displays the measurement result in text format together with the position on the CIE1931 (or CIE1964) chromaticity diagram.

When 2 degrees of view of angle is selected in Hardware Setting, this mode shows CIE1931.

CIE1964 appears when 10 degrees of view of angle is selected.

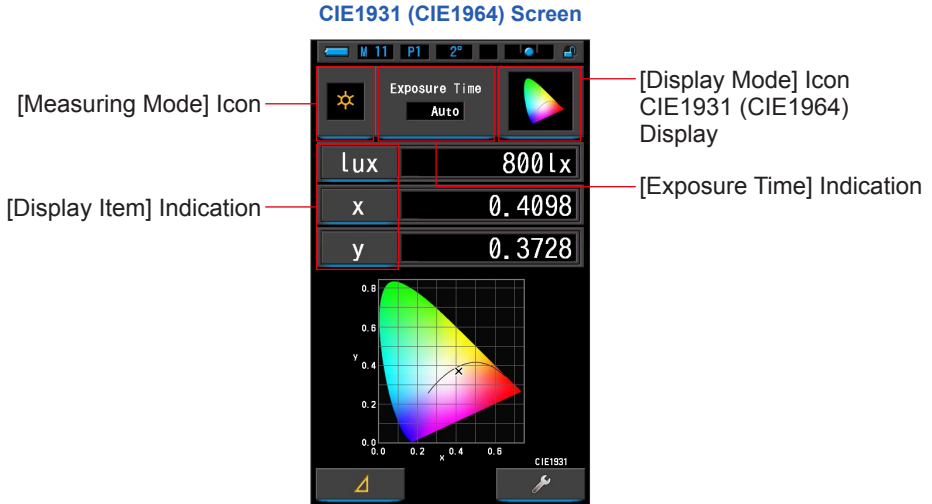



Operation

1. Touch the [CIE1931 (CIE1964)] icon on the Display Mode screen.
The CIE1931 (CIE1964) screen will be displayed. (➔ P28)
2. Touch the [Measuring Mode] icon.
The Measuring Mode Selection screen will be displayed. Select the desired measuring mode to use. (➔ P22)
3. Touch the [Exposure Time] indication in the Measurement screen.
Set the exposure time to Auto, 0.1 sec, or 1.0 sec during ambient light measurement. (➔ P24)

4. Press the Measuring Button 5 to measure.

The Light Selection Ring 2 should be set to L () when taking ambient light measurements.

When measuring flash units, select Range L () or Range H () depending on the brightness of the flash. (→ P77, → P78)

Measurements can now be made.

Light Selection Ring 2

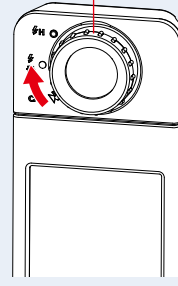

Measuring Button 5

5. The measured value is indicated by a black "x".

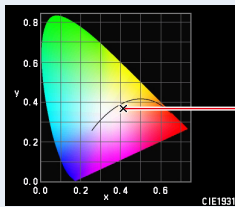

Measured value



NOTE

Measurement and display will take longer in light levels below 30lx. The LCD illumination will normally switch off during measurement to avoid influence to measurement.

6. Memorize the measurement results.

Measurement results can be memorized.

To record measurements, press Memory Button 7. (→ P83)

4-3-6

Displaying in CIE1931 (CIE1964) Comparison [CIE1931 (CIE1964) Comp.] Mode

Displays the measured result in text format together with the position on the CIE1931 (or CIE1964) chromaticity diagram. The measured result can be compared with up to 2 sets of memorized values.

When 2 degrees of view of angle is selected in Hardware Setting, this mode shows CIE1931.

CIE1964 appears when 10 degrees of view of angle is selected.

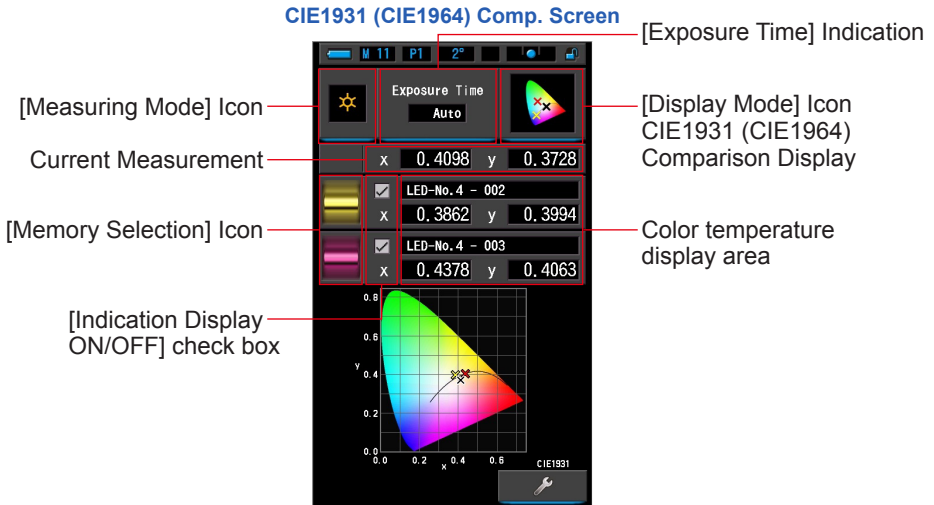

Operation

1. Touch the [CIE1931 (CIE1964) Comp.] icon on the Display Mode screen.

The CIE1931 (CIE1964) Comp. screen will be displayed. (➔ P28)

2. Touch the [Measuring Mode] icon.



The Measuring Mode Selection screen will be displayed. Select the desired measuring mode to use. (➔ P22)

3. Touch the [Exposure Time] indication in the Measurement screen.

Set the exposure time to Auto, 0.1 sec, or 1.0 sec during ambient light measurement. (➔ P24)

4. Press the Measuring Button ⑤ to measure.

The Light Selection Ring ② should be set to L () when taking ambient light measurements.

When measuring flash units, select Range L () or Range H () depending on the brightness of the flash. (➔ P77, ➔ P78)

Measurements can now be made.

Light Selection Ring ②

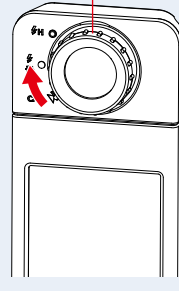

Measuring Button ⑤



NOTE

Measurement and display will take longer in light levels below 30lx. The LCD illumination will normally switch off during measurement to avoid influence to measurement.

5. The current measurement value is indicated by a black "x".

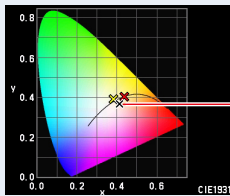

Measured value

6. Touch the [Memory Selection] icon.

The [CIE1931 (CIE1964) Comp.] screen will be displayed.

CIE1931 (CIE1964) Comp. Screen

CIE1931 (CIE1964) Comp. Memory Screen

Current Measurement

[Memory Selection] Icon

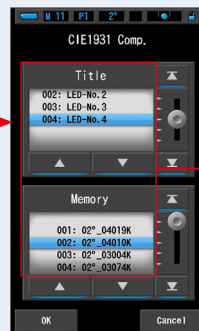
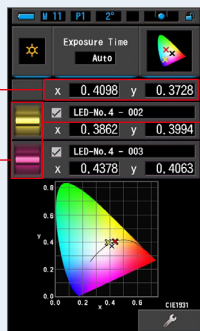

Memory Selection Area

When no data is memorized, a message will be displayed in a popup screen.

Memory Selection Pop-up Screen

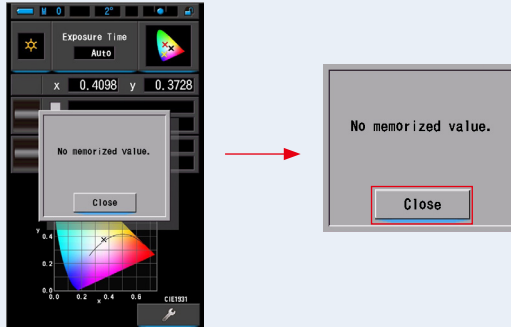

If you encounter the "No memorized value" screen, touch the [close] button to return to the CIE1931 (1964) Comp. screen.

7. Select the desired memory data to compare the CIE1931 (CIE1964).

When a title is selected, the memory linked to the title will be displayed. Select a memorized reading for display and comparison.

To select a title and a memory, match them with the blue background positions.

CIE1931 (CIE1964) Comparison Title/Memory Screen

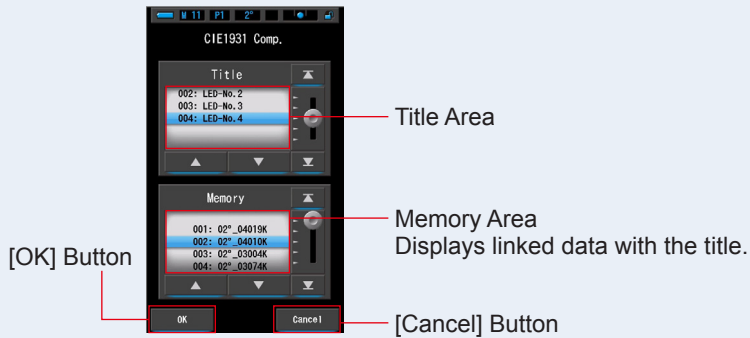

8. Touch the [OK] button.

Confirms the setting and returns to the CIE1931 (CIE1964) Comp. screen.

To cancel the setting, touch the [Cancel] button.

9. The titles and measurements of the selected memory data will be displayed on the CIE1931 (1964) Comp. screen.

Memory Title Display

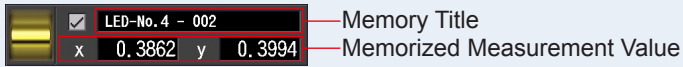

10. Display the selected value on the CIE1931 (CIE1964) comparison screen.

Touch the [Indication Display ON/OFF] to hide/show a line graph on the screen.

* shows line. hides line.

CIE1931 (1964) Comp. Screen

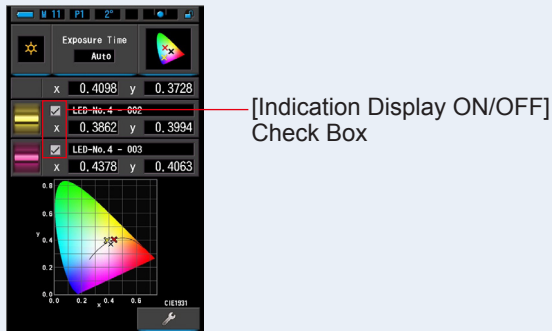

11. Memorize the measurement results.

Measurement results can be memorized.

To record measurement, press Memory Button ⑦. (→ P83)



NOTE

During CIE1931 (or CIE1964) comparison, the Contrast Function is not available and  button will be hidden even if a Preset with this function is selected.

4-3-7 Displaying in CIE1976 [CIE1976] Mode

Displays the measurement result in text format together with position on the CIE1976 chromaticity diagram.

CIE1976 Screen

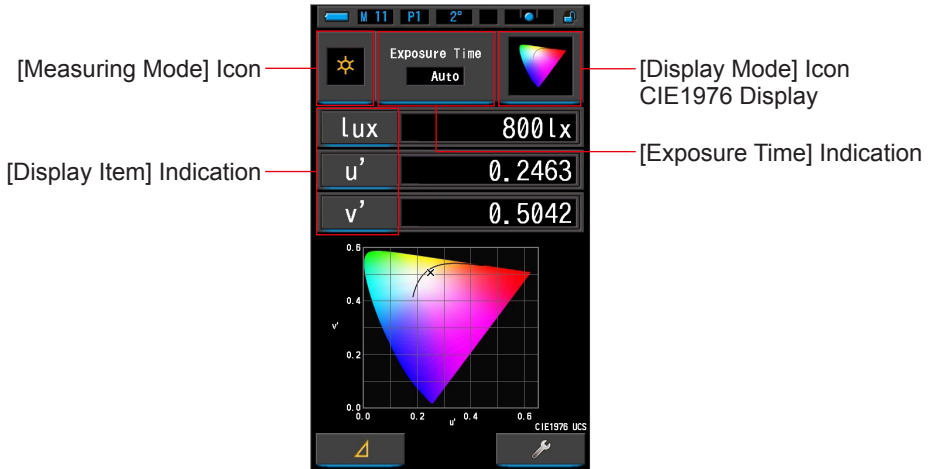

Operation

1. Touch the [CIE1976] icon on the Display Mode screen.
The CIE1976 screen will be displayed. (⇒ P28)
2. Touch the [Measuring Mode] icon.
The Measuring Mode Selection screen will be displayed. Select the desired measuring mode to use. (⇒ P22)
3. Touch the [Exposure Time] indication in the Measurement screen.
Set the exposure time to Auto, 0.1 sec, or 1.0 sec during ambient light measurement. (⇒ P24)

4. Press the Measuring Button 5 to measure.

The Light Selection Ring 2 should be set to L (⚡ (●)) when taking ambient light measurements.

When measuring flash units, select Range L (⚡ (●)) or Range H (⚡⚡ (●)) depending on the brightness of the flash. (➔ P77, ➔ P78)

Measurements can now be made.

Light Selection Ring 2

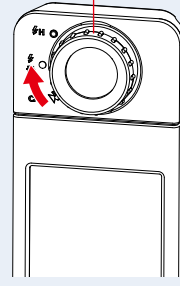

Measuring Button 5

5. The measured value is indicated by a black "x".

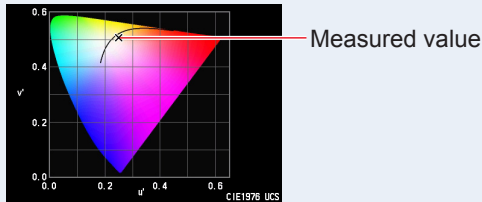

NOTE

Measurement and display will take longer in light levels below 30lx. The LCD illumination will normally switch off during measurement to avoid influence to measurement.

6. Memorize the measurement results.

Measurement results can be memorized.

To record measurements, press Memory Button 7. (➔ P83)

4-3-8

Displaying in CIE1976 Comparison [CIE1976 Comp.] Mode

Displays the measurement result in text format together with the position on the CIE1976 chromaticity diagram. The measured result can be compared with up to 2 sets of Memorized Value.

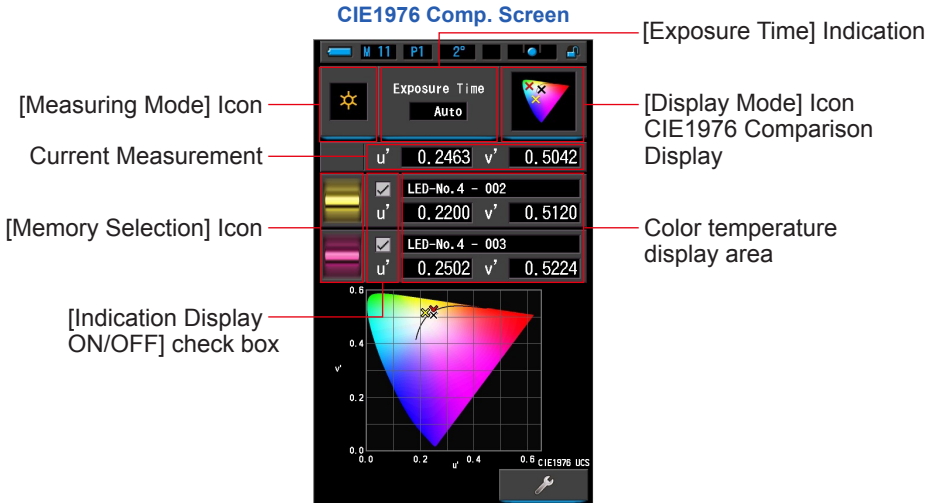

Operation

1. Touch the [CIE1976 Comp.] icon on the Display Mode screen.

The CIE1976 Comp. screen will be displayed. (➔ P28)

2. Touch the [Measuring Mode] icon.

The Measuring Mode Selection screen will be displayed. Select the desired measuring mode to use. (➔ P22)

3. Touch the [Exposure Time] indication in the Measurement screen.

Set the exposure time to Auto, 0.1 sec, or 1.0 sec during ambient light measurement. (➔ P24)

4. Press the Measuring Button ⑤ to measure.

The Light Selection Ring ② should be set to L (⚡) when taking ambient light measurements.

When measuring flash units, select Range L (⚡) or Range H (⚡H) depending on the brightness of the flash. (➔ P77, ➔ P78)

Measurements can now be made.

Light Selection Ring ②

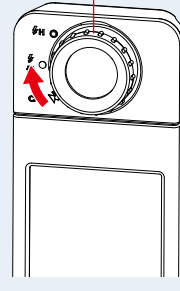

Measuring Button ⑤



NOTE

Measurement and display will take longer in light levels below 30lx. The LCD illumination will normally switch off during measurement to avoid influence to measurement.

5. The current measurement value is indicated by a black "x".

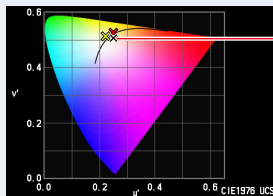

Measured value

6. Touch the [Memory Selection] icon.

The [CIE1976 Comp.] screen will be displayed.

CIE1976 Comp. Screen

CIE1976 Comp. Memory Screen

[Memory Selection] Icon

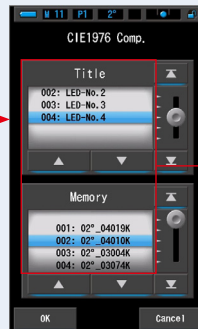
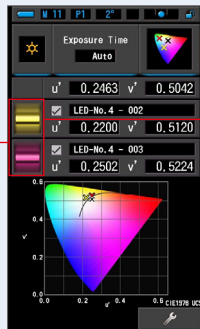

Memory Selection Area

When no data is memorized, a message will be displayed in a pop-up screen.

Memory Selection Pop-up Screen

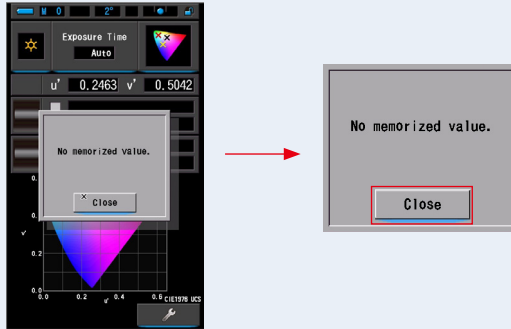

After you confirmed the message "No memorized value.", touch the [Close] button. Returns to the CIE1976 Comp. screen.

7. Select the desired memory data to compare.

When a title is selected, the memory linked to the title will be displayed. Select memories to compare.

To select a title and a memory, match them with the blue background positions.

CIE1976 Comparison Title/Memory Screen

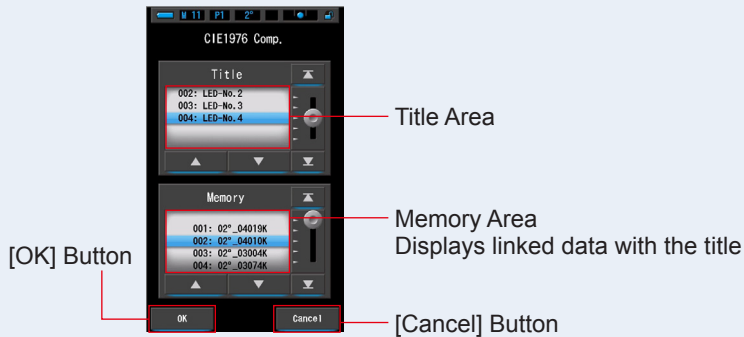

8. Touch the [OK] button.

Confirms the setting and returns to the CIE1976 Comp. screen.

To cancel the setting, touch the [Cancel] button.

9. The titles and measurements of the selected memories will be displayed on the CIE1976 Comp. screen.

Memory Title Display

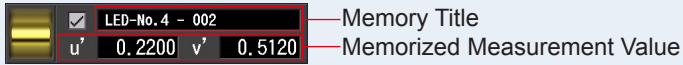

10. Display the selected value on the CIE1931 (CIE1964) comparison screen.

Touch the [Indication Display ON/OFF] to hide/show a line graph on the screen.

* shows line. hides line.

CIE1976 Comp. Screen

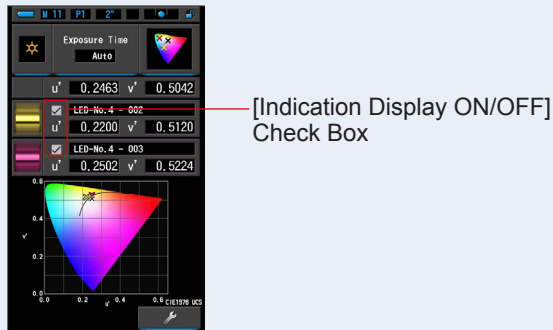

11. Memorize the measurement results.

Measurement results can be memorized.

To record a measurement, press Memory Button . (→ P83)



NOTE

During CIE1976 comparison, the Contrast Function is not available and  button will be hidden even if a Preset with this function is selected.

4-3-9 Displaying Setting [Setting] Screen

The meter can be customized to desired measuring and display preferences. For details, see "7-1-1 Item List". (➔ P107)

Setting Screen
Page 1

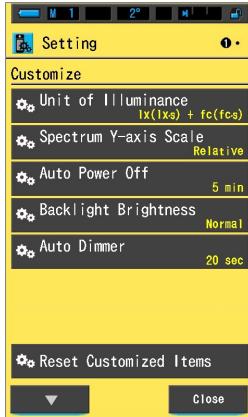

Setting Screen
Page 2



NOTICE

Pressing the Menu Button ⑥ will terminate the settings and return to the Display Mode Selection screen.

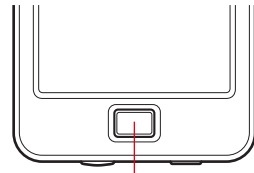

Menu Button ⑥

* Models sold in some countries do not display illuminance and exposure in "fc (fc-s)" due to legal restrictions. In this case, "Unit of Illuminance" is not displayed.

Operation

1. Touch the [Setting] icon on the Display Mode Selection screen.
The Setting screen will be displayed.

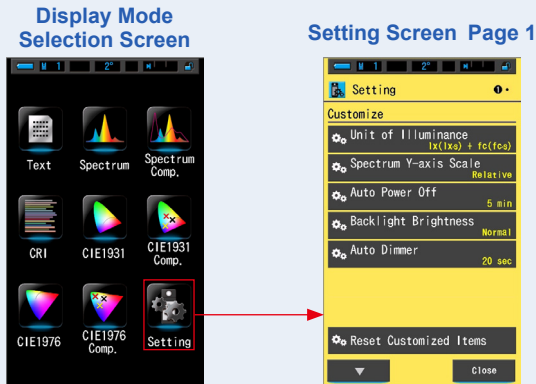

2. Setting shows selectable items in white letters and selected values in yellow letters.
Touch each item to change the setting.

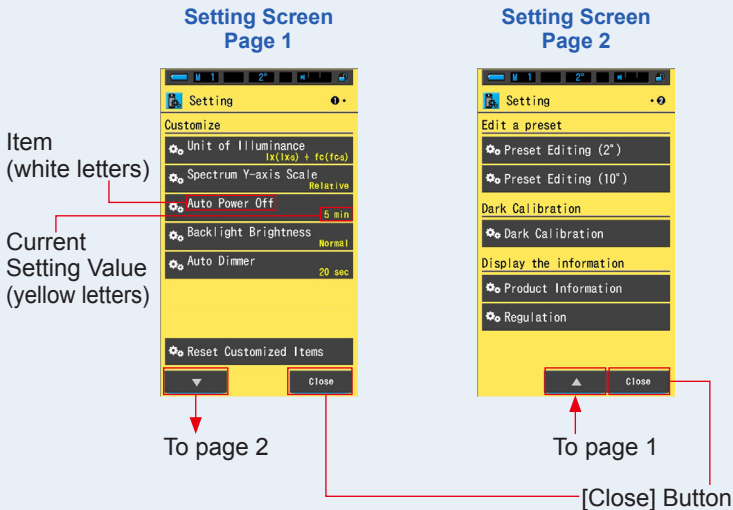

When the [Close] button is touched, the display returns to the Display Mode Selection screen. For more information about how to set and the details of specifications, see "7-1-1 Item List". (▶ P107)

5. Measuring Light Sources [Measurement Screen]

| 5-1 | Measurement Method |
|-------|---|
| 5-1-1 | Balancing Color Temperatures of Light Sources |

Take a measurement by facing the Light Receptor ① towards the light source to correctly measure the color temperature of the light source.

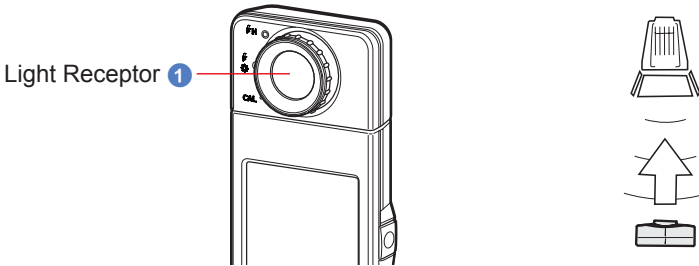

NOTICE

- When taking measurements, the C-7000 should be located at a distance that is approximately 10 times (10X) the diameter of the light source being measured.
- When measuring the light source, be careful not to measure the light reflected off from ceiling, wall or floor because precision of measurements may be affected.
- Because the precision of measurements may be affected, be careful not to damage or dirty the white surface of the Light Receptor ①. If the Light Receptor ① becomes dirty, wipe it with a dry and soft cloth. Never use organic solvents such as thinner or benzene.
- There may be those who are sensitive to flash or other strong lights (photosensitivity), and they may be negatively affected by light. Therefore, be careful when people are nearby during measurement.

5-2

Measurement in Ambient Light Mode

Select Ambient Light Mode when taking measurements of natural light (sunlight), and continuous light sources such as LED, tungsten lamps and fluorescent lights.

**NOTICE**

Do not look directly into sunlight or other strong light when measuring. It may cause severe eye damage or even loss of vision.

Operation

1. On the Measurement screen, touch the [Measuring Mode] icon and select the [Ambient Mode] icon on the next screen. (→ P22)
Select the measuring mode.

Measurement Screen



Measuring Mode Selection Screen

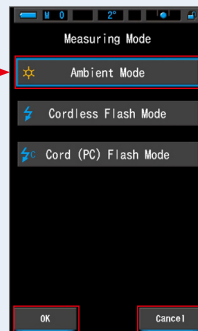

[OK] Button [Cancel] Button

2. Touch the [OK] button.

Confirms and returns to the Measurement screen.

To return to the Measurement screen without confirming, touch the [Cancel] button.

3. Touch the [Exposure Time] indication on the Measurement screen.

Exposure Time Screen appears. (→ P24)

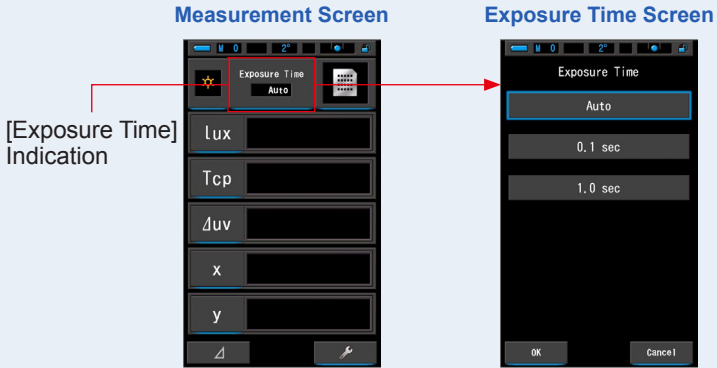

4. Select the exposure time.

Touch the [Auto], [0.1 sec] or [1.0 sec] button.

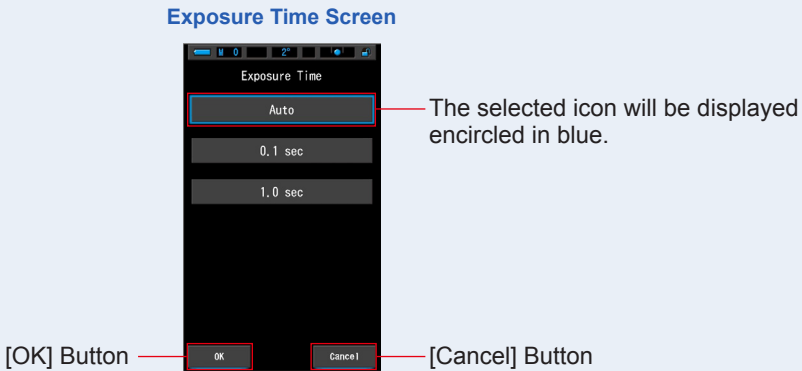

5. Touch the [OK] button.

Confirms and returns to the Measurement screen.

To return to the Measurement screen without confirming, touch the [Cancel] button.

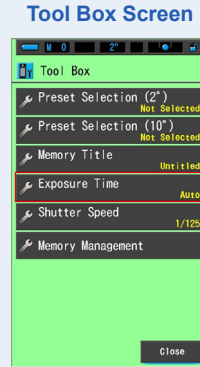
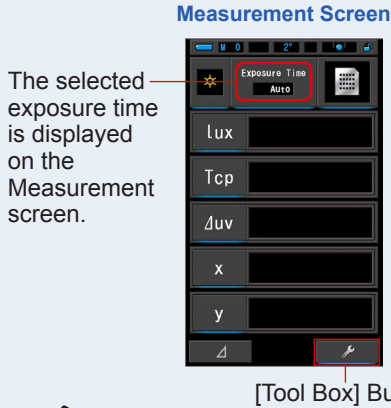

NOTE

Exposure Time can also be set in the Tool Box. (→ P101)

6. Confirm the light measuring range.

When you return to the Measurement screen, make sure to select Range L ().

7. Press the Measuring Button .

Measurement will be taken and the light source values will be displayed.

While the button is held, the meter measures continuously.

When the button is released, the measurements will stop and the light source value at the time of release will be displayed.

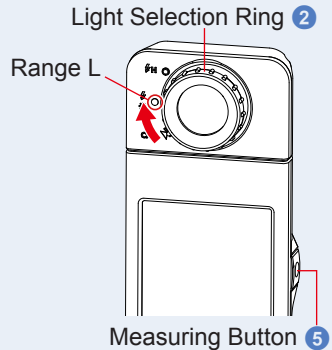

NOTE

- [Over] or [Under] will be displayed if the light source illumination is too bright or not bright enough, or if the color temperature is out of the measurement range, when the Measuring Button is pressed.
In this case, adjust the brightness or color temperature of light source.
- Measurement and display will take longer in light levels below 30lx. The LCD illumination will normally switch off during measurement to avoid influence to measurement.

Measurement in Ambient Light Mode is complete.

**NOTE**

You can select a previously created Preset value from Preset Selection in the Tool Box. (➔P122)

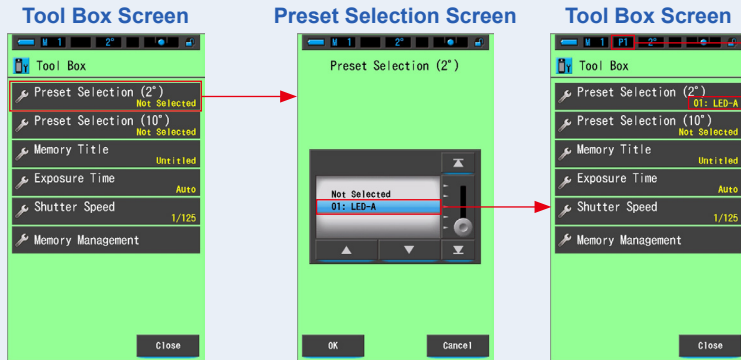

The set content
is displayed

The selected Preset
No. is displayed

If no presets have been created, the Preset Selection will be grayed out and touching the button will not display the Preset Selection Display.

**NOTICE**

**A Preset value must be created and saved in the Preset Editing function under the "Setting Mode" icon before it can be used.
Preset Selection buttons will be grayed out until settings are created.**

5-3 Measurement in Cordless Flash Mode

Cordless Flash Mode is preferable when the flash to subject distance is too far to use a sync cord or when wireless measuring is desired. In this measuring mode, the meter will go into measurement standby mode (for 90 seconds) to wait for a burst of flash to measure.

Operation

1. On the Measurement screen, touch the [Measuring Mode] icon and select the [Cordless Flash Mode] icon on the next screen. Select the measuring mode. (→ P22)

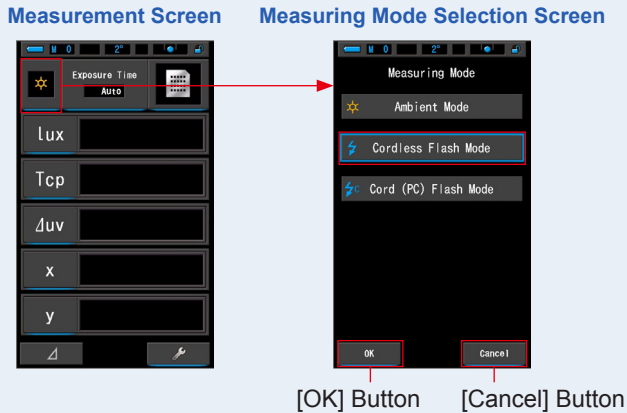

2. Touch the [OK] button.

Confirms and returns to the Measurement screen.

To return to the Measurement screen without confirming, touch the [Cancel] button.

3. Touch the [Shutter Speed] indication on the Measurement screen.

Set the shutter speed used for measurements. (➔ P25)

Match the blue background with the desired shutter speed.

Measurement Screen

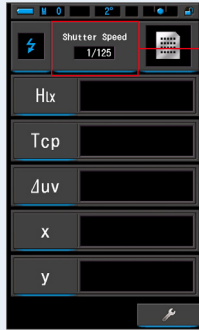

Shutter Speed Screen

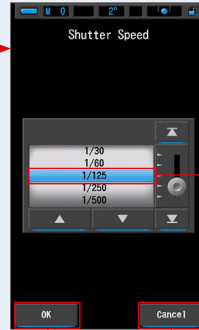

The selected value is indicated by the blue background.

[OK] Button

[Cancel] Button

NOTICE

If you are using this measurement to judge color for photographic reproduction by adjustable camera, be sure to use a shutter speed that synchronize with the camera and flash system.

NOTE

Shutter speed can also be set in the Tool Box. (➔ P103)



4. Confirm the light measuring range.

When you return to the Measurement screen,

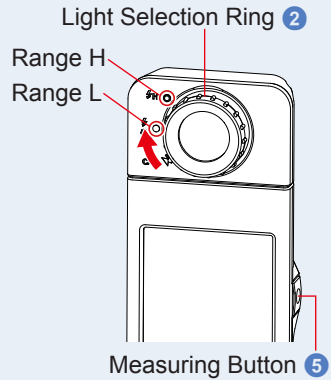
select Range L  or Range H  depending on the brightness of the flash.



NOTE

- Range L : Select when measuring small and low power flash units (lower than 640lx-s), [Over] will appear if flash power is too high. Select Range H.
- Range H : Select when measuring powerful flash units (brighter than 580lx-s) [Under] will appear if flash power is too low. Select Range L.

5. Press the Measuring Button .

The meter will enter measurement standby mode.

While the icon is blinking, manually trigger the flash.

The [Measuring Mode] icon will blink for 90 seconds when measuring.

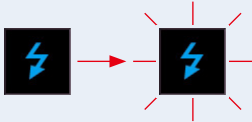

The display panel illumination will dim when the Measuring Button is pressed as the display illumination can affect the reading. This is normal.

When the flash light is fired, the measured value will be displayed for 3 seconds, and the display will return to measurement standby mode.

To cancel standby mode, touch the screen or press the Menu Button .



NOTE

When the icon stops blinking before triggering the flash, or when you want to restart the 90-second delay cycle again, press Measuring Button  again.

Measurement in Cordless Flash Mode is complete.



CAUTION

- Do not trigger flash while skin or other objects are in contact with the flash tube. Do not touch the flash tube after repeated flashes. (It may cause burns.)
- Do not trigger flash while near the eyes of people or animals. (It may temporarily affect vision.)
- The flash may be triggered suddenly. Because there is the possibility of burns or negative effects on vision, please handle with care.



NOTICE

- If the flash output power is too weak compared to the surrounding light, the meter, when set in cordless mode, may not detect the flash output. In this case, use "5-4 Measurement in Cord (PC) Flash Mode". (➔ P69)
- Pulsed light sources such as fluorescent lights or special lighting could cause the meter to take cordless flash measurements in rare cases. In these situations, use "5-4 Measurement in Cord (PC) Flash Mode". (➔ P69)
- If the Light Receptor ① detects a sudden and bright change in lighting intensity, the meter may mistakenly take a measurement. To avoid this, take "5-4 Measurement in Cord (PC) Flash Mode". (➔ P69)
- Do not use Cordless Flash Mode for sources which gradually increase to peak power, such as traditional flash bulbs, as they cannot be detected and measured. Be sure to take "5-4 Measurement in Cord (PC) Flash Mode". (➔ P69)
- When using Cordless Flash Mode, the LCD screen illumination dims during measurement, and the LCD is illuminated for 3 seconds after measurement. To cancel standby mode, touch the screen or press the Menu Button ⑥.
- In the Cordless Flash mode, the measured color temperature may change depending on the shutter speed set for flash measurement and the amount of ambient light present when the measurement is made.



NOTE

- When using the meter in Cordless Flash Mode, it is possible to mount the meter to a light stand, tripod or similar support using the Tripod Socket ⑩.
- [Over] or [Under] will be displayed if the light source illumination is too bright or not bright enough, or if the color temperature is out of the measurement range, when the Measuring Button is pressed. In this case, adjust the brightness or color temperature of light source, or switch the light range. (➔ P78)

5-4

Measurement in Cord (PC) Flash Mode

Cord (PC) Flash Mode is preferable when lighting conditions prevent the use of cordless measurements or when certain types of equipment require a physical sync connection.

In Cord (PC) Flash Mode, the meter and flash unit are connected with a Sync Cord (sold separately).



CAUTION

- Do not handle this product with wet hands, or leave it in the rain or in a location where it may be splashed with water, submerged, or come into contact with moisture. There is a danger of electric shock in Cord (PC) Flash Mode. This may also result in damage to the product.
- When using flash with high voltage, there is a danger of electric shock if you touch the Sync Terminal 12. Handle the flash with care when using for measurement.

Operation

1. On the Measurement screen, touch the [Measuring Mode] icon and select the [Cord (PC) Flash Mode] icon on the next screen. Select the measuring mode. (→ P22)

Measurement Screen



Measuring Mode Selection Screen

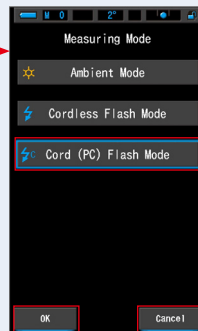

[OK] Button

[Cancel] Button

2. Touch the [OK] button.

Confirms and returns to the Measurement screen.

To return to the Measurement screen without confirming, touch the [Cancel] button.

3. Touch the [Shutter Speed] indication on the Measurement screen.

Set the shutter speed used for measurements. (→ P25)

Match the blue background with the desired shutter speed.

Measurement Screen

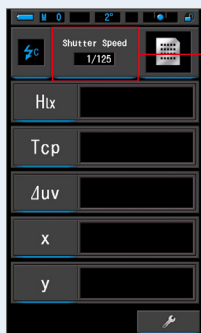

Target CCT Screen

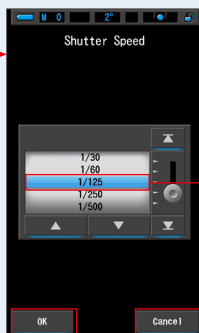

The selected value is indicated by the blue background.

[OK] Button [Cancel] Button

NOTICE

If you are using this measurement to judge color for photographic reproduction by adjustable camera, be sure to use a shutter speed that synchronize with the camera and flash system.

NOTE

Shutter speed can also be set in the Tool Box. (→ P103)

4. Connect the sync cord (sold separately) to the Sync Terminal 12 of the meter.

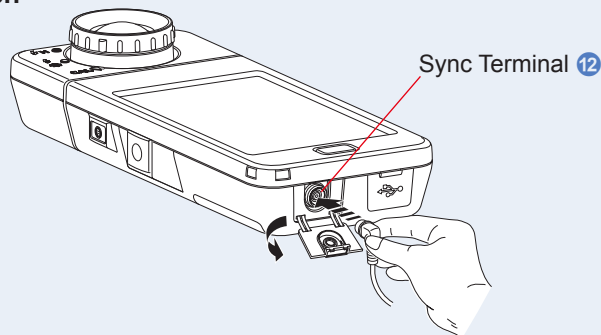

⚠ CAUTION

- Depending on the flash equipment used, the flash may be triggered when the sync cord is connected to the Sync Terminal ⑫ or when operating the Power Button ③. Because there is the possibility of burns or negative effects on vision, please handle with care.

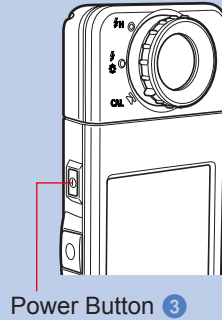

📌 NOTICE

- If you are using this measurement to judge color for photographic reproduction by adjustable camera, be sure to use a shutter speed that synchronize with the camera and flash system.
- If the triggering voltage of the flash used is extremely low, the flash may not trigger. In this case, use "5-3 Measurement in Cordless Flash Mode". (➔ P65)

5. Confirm the light measuring range.

When you return to the Measurement screen,

select Range L ⚡ (🔵) or Range H ⚡H (🔵) depending on the brightness of the flash.

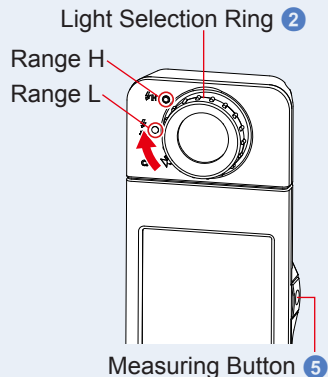

📝 NOTE

- Range L ⚡ (🔵): Select this when measuring small and low power flash units (lower than 640lx·s), [Over] will appear if flash power is too high. Select Range H.
- Range H ⚡H (🔵): Select when measuring powerful flash units (brighter than 580lx·s) [Under] will appear if flash power is too low. Select Range L.

6. Press the Measuring Button ⑤.

Measurement will be taken with flash, and the light source values will be displayed.

Because it affects measurement while measuring, the LCD backlight will dim. This is normal.

Measurement in Cord (PC) Flash Mode is complete.



CAUTION

- Depending on the flash equipment used, the flash may be triggered when the sync cord is connected to the Sync Terminal ⑫ or when operating the Power Button ③. Because there is the possibility of burns or negative effects on vision, please handle with care.
- Do not trigger flash while skin or other objects are in contact with the flash tube. Do not touch the flash tube after continuous flashes. (It may cause burns.)
- Do not trigger flash while near the eyes of people or animals. (It may temporarily affect vision.)
- The flash may be triggered suddenly. Because there is the possibility of burns or negative effects on vision, please handle with care.



NOTICE

- If the triggering voltage of the flash used is extremely low, the flash may not trigger. In this case, use "5-3 Measurement in Cordless Flash Mode". (➔ P65)
- In the Cordless Flash mode, the measured color temperature may change depending on the shutter speed set for flash measurement and the amount of ambient light present when the measurement is made.





NOTE

[Over] or [Under] will be displayed if the light source illumination is too bright or not bright enough, or if the color temperature is out of the measurement range, when the Measuring Button is pressed. In this case, adjust the brightness or color temperature of light source, or switch the light range. (➔ P78)

5-5 Monitor Function (in Ambient Light Mode only)

The Monitor function displays a difference between the preset reference value and the measured value.

When you touch the Delta icon () in the Display mode, it changes to () (This function is not activated in Spectrum Comp., CIE1931/1964 Comp. and CIE1976 Comp. mode).

When Monitor Function is selected, the difference between the preset and current value is shown while you are pressing Measuring Button .

When the Measuring Button  is released, the preset reference value is displayed in the yellow letter.

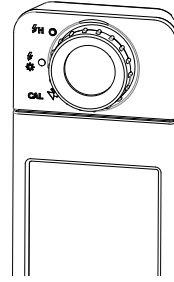

Measuring Button 

Operation

1. Touch the [Preset Selection (2°) (Preset Selection (10°))] button in the Tool Box.

The Preset Selection screen will be displayed.



NOTICE

A Preset value must be created and saved in the Preset Editing function under the "Setting Mode" icon before it can be used.
Preset Selection buttons will be grayed out until settings are created.

2. Select desired preset no. (1 ~ 5).

Match the blue background with the desired shutter speed.

Preset Selection Screen

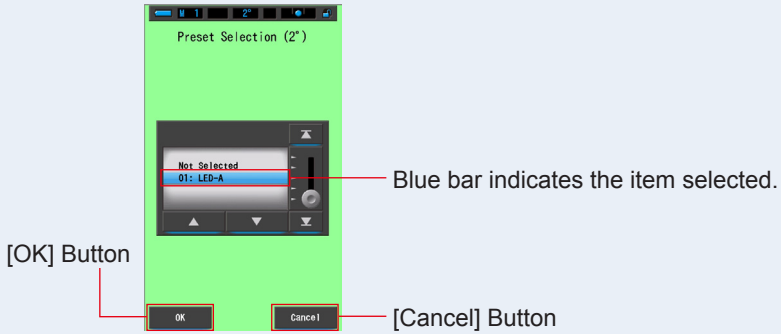

Be sure to set Preset Selection to "Not Selected" when no correction is desired.

3. Touch the [OK] button.

Confirm and return to the Measurement screen.

To return to the Measurement screen without confirming, touch the [Cancel] button.

Tool Box Screen

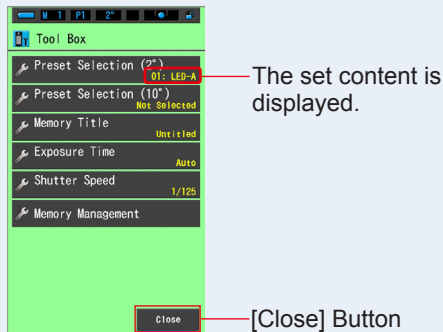

4. Touch the [Close] button.

Returns to the Measurement screen.

The selected status will be displayed on the status bar.

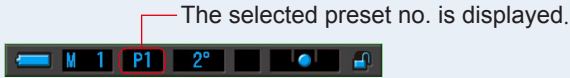



The preset is set.

5. The preset is set. Touch the [Delta] icon ().

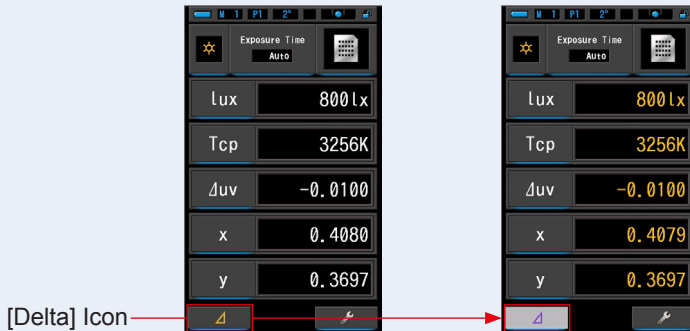
The [Delta] icon will change ().



6. Hold the Measuring Button .

While the [Delta] icon is activated (), the difference with the preset reference value is displayed as long as the Measuring Button  is pressed.



7. Monitoring Function is complete.



When the Measuring Button **5** is released, the preset reference value is displayed.

8. Touch the [Delta] icon ().

The values measured last is displayed instead of the Delta icon (.



NOTE

- If Preset is not selected, the Monitor Function does not start even when you touch its Delta icon (.
- The [Delta] icon () is deactivated when the power is turned OFF.
- When the [Delta] icon is displayed, the Memory Button **7** is disabled.

5-6

When [Over] or [Under] is Displayed

When [Over] or [Under] is displayed, the light source is out of measuring range.



5-6-1

Display of [Over] or [Under]

When [Over] is displayed:

If the amount of light being measured is brighter than the maximum measuring range, [Over] is displayed.



When measuring ambient light, decrease the brightness of the illumination.

When measuring high power flash light, turn the Light Selection Ring ②, and change the range from L ⚡ () to H ⚡H (), or lower the flash output power. ⚙️ 

When [Under] is displayed:

If the amount of light being measured is lower than the minimum measuring range, [Under] is displayed.

When measuring ambient light, increase the brightness of the illumination.

When measuring flash light, turn the Light Selection Ring ②, and change the range from H ⚡H () to L ⚡ (), or raise the flash output power. ⚙️ 

Light Selection Ring ②

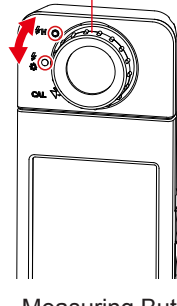





Measuring Button ⑤

 **NOTE**

Measurement and display will take longer in light levels below 30lx. The LCD illumination will normally switch off during measurement to avoid influence to measurement.

5-6-2 Changing the Light Range

Change and use the light range depending on the brightness of the flash.

| Light Selection Ring (Status Bar Display) | | | Content |
|---|---|---|--|
| Dark Calibration Position |  | CAL | Select for dark calibration only. Measurement cannot be made in this position. |
| Range L |  |  | Select for ALL ambient light measurement, and low power flash units (lower than 640lx·s) |
| Range H |  |  | Select for powerful flash units (brighter than 580lx·s) only. |

Turn the Light Selection Ring ② and select the desired range.
The set range will be displayed on the LCD screen's status bar.

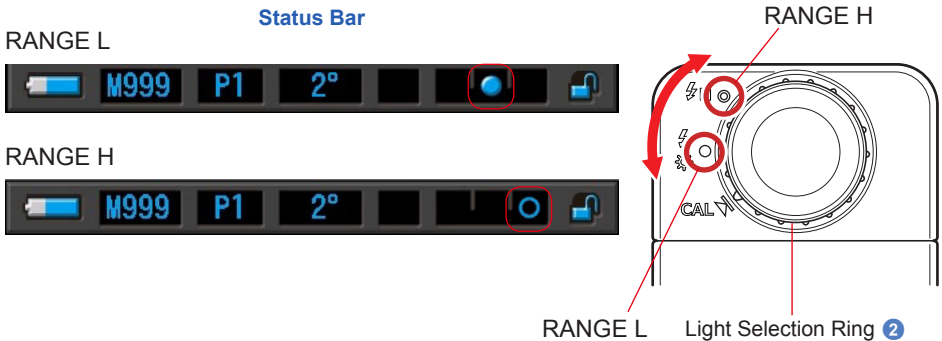

6. Measurement Tool [Tool Box] Screen

Selecting Screens from the Tool Box

Touch the [Tool Box ()] icon in the Measurement screen to display the Tool Box screen. (→ P17) You can select screens from the Tool Box as follows.

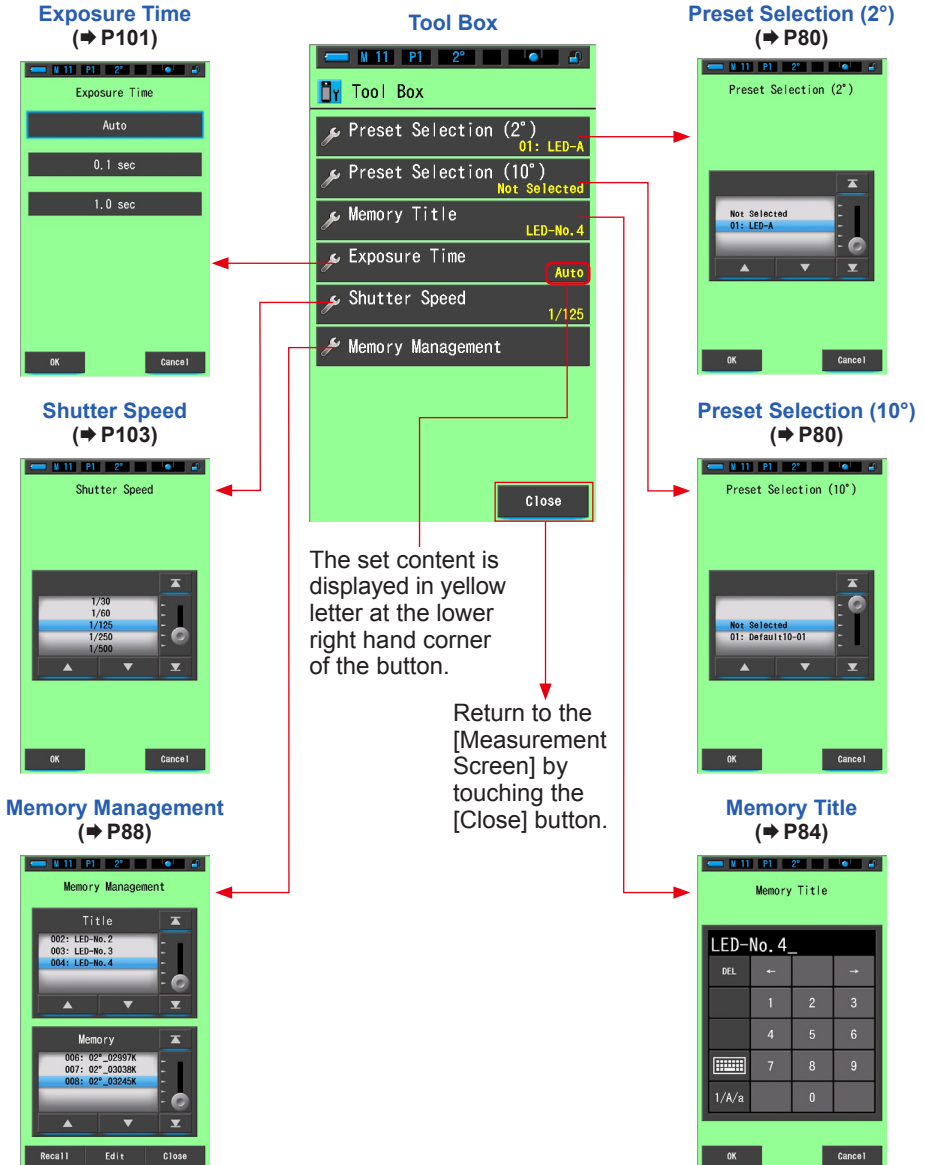

6-1 Setting Preset Contents [Preset Selection] Screen

You can select a previously created Preset value from Preset Selection in the Tool Box.

Select a preset item of Preset Selection (2°) or Preset Selection (10°).

If the "Preset Selection List" is set to be displayed in the "Preset Editing" function of "Setting", only these preset items are displayed on the drum.

Preset Selection (2°) Screen

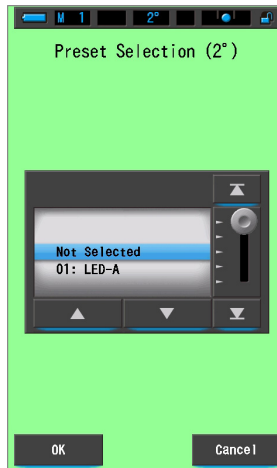

Operation

1. Touch the [Preset Selection (2°) (Preset Selection (10°))] button in the Tool Box.

The Preset Selection screen will be displayed.

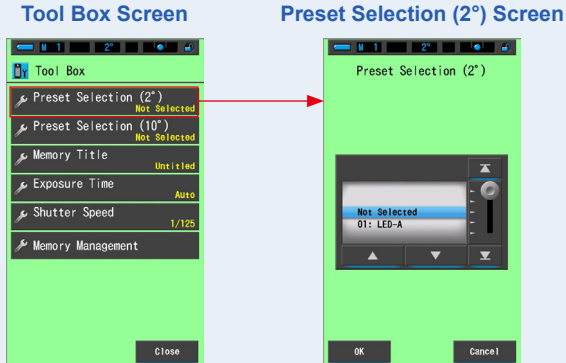

NOTICE

A Preset value must be created and saved in the Preset Editing function under the "Setting Mode" icon before it can be used. Preset Selection buttons will be grayed out until settings are created.

2. Select desired preset no. (1 ~ 5).

Match the blue background with the desired shutter speed.

Preset Selection Screen

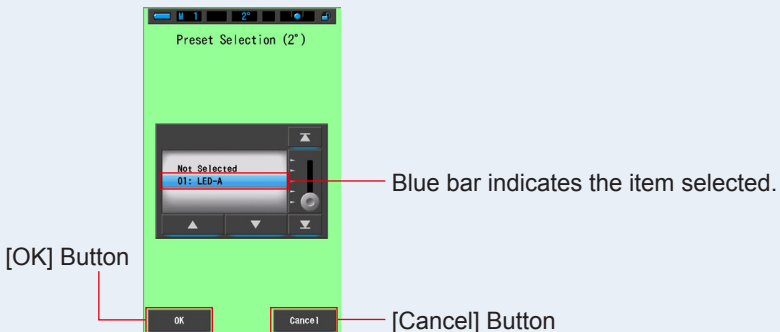



Be sure to set Preset Selection to "Not Selected" when no correction is desired.

3. Touch the [OK] button.

Confirm and return to the Measurement screen.

To return to the Measurement screen without confirming, touch the [Cancel] button.

Tool Box Screen

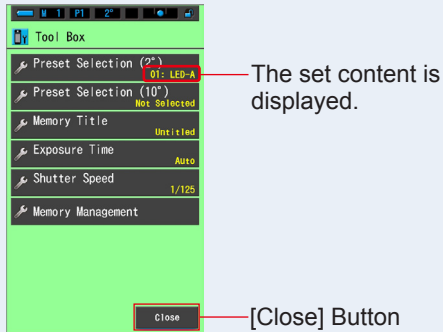

4. Touch the [Close] button.

Returns to the Measurement screen.

The selected status will be displayed on the status bar.

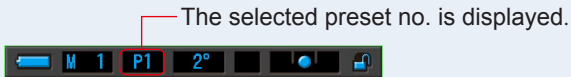

The preset is set.

6-2 Using the Memory Function

The memory function enables storing light source data for single sources and groups of sources for recall at any time. Up to 999 measurements can be stored. Memory function also enables naming or renaming the title of memory and clearing the stored value.

Memory Management Screen



Tool Box Screen

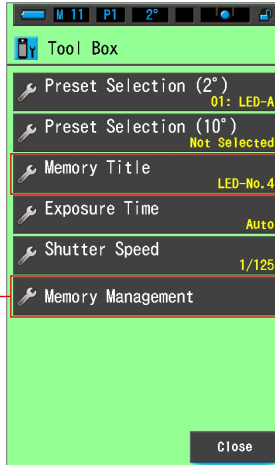

Memory Title Screen

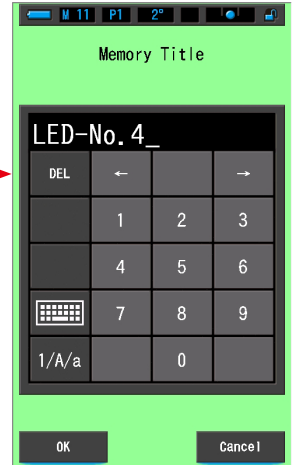

Memory Recall Screen



Memory Edit Screen



Renaming Memory Title Clearing Memorized Value

6-2-1

Naming Measurement Values Being Memorized [Memory Title] Screen

You can create special titles for memorized values to make them easier to select, view and use data later.

To use this function the order of operation:

- * Create memory title
- * Measure light source
- * Press Memory button **7** to memorize

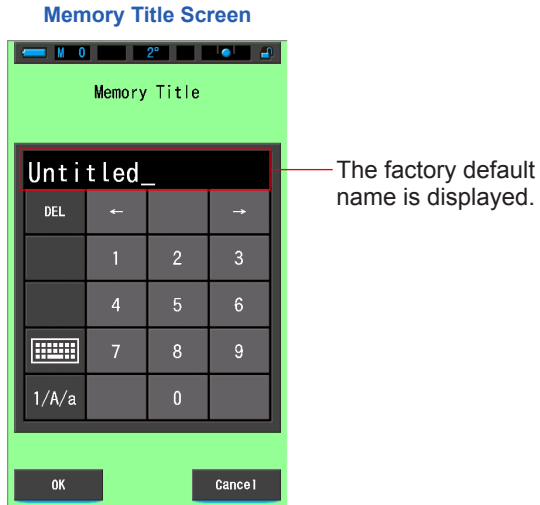

NOTE

- A title can be a maximum of 16 alphanumeric characters.
- More than one measurement can be stored under one title.
- Up to 999 titles can be created.

Operation

1. Touch and select the [Memory Title] button in the Tool Box.
The Memory Title screen will be displayed.

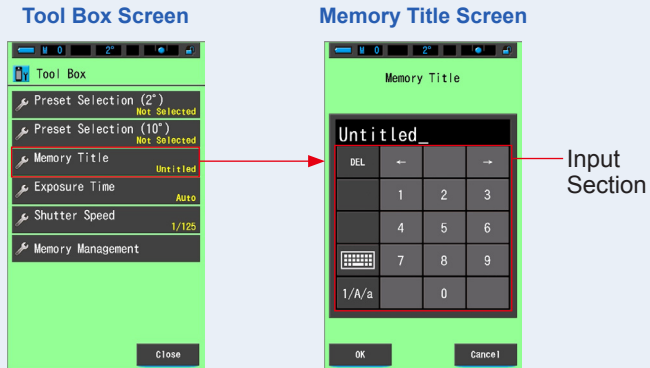

2. Enter the memory title. (→ P19)

Use the keyboard to create a name for the measured light.

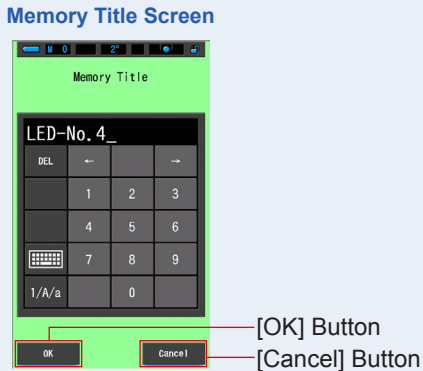

3. Touch the [OK] button.

Confirms and returns to the Tool Box screen.

To return to the Tool Box screen without confirming, touch the [Cancel] button.

4. Touch the [Close] button.

Returns to the Measurement screen.

Tool Box Screen



[Close] Button

The memory title is entered.



NOTICE

The memory title needs to be entered before memorizing.

The memory title can be edited and renamed at any time afterward using the Memory Management function. (→ P93)

5. Measure light.

Press Measuring Button ⑤ to take a measurement.

The Light Selection Ring ② should be set to L (⚡) when taking ambient light measurements.

When measuring flash units, select Range L (⚡) or Range H (⚡H) depending on the brightness of the flash. (→ P77, → P78)

Light Selection Ring ②

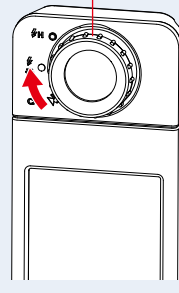

Measurement Screen

Measuring Button ⑤



Measurement



6. Press Memory Button 7 to memorize light source values and link the reading to the created title name.

The Memory reflected on the status bar.

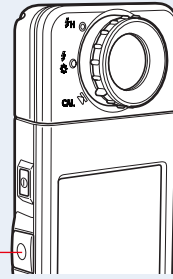

Memory Button 7

6-2-2 Recalling Measurement Results [Memory Recall] Screen

The Memory Recall screen enables selecting a specific Title and Memory number to view and inspect values stored in the memory under the specific combination.

Ex.) Memory Recall Mode Spectrum Mode

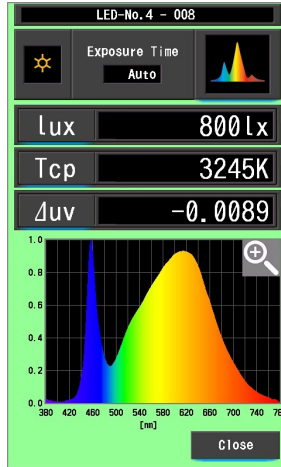

Operation

1. Touch the [Memory Management] button in the Tool Box. Memory Management screen will be displayed.
2. Select the "Title" and "Memory" to recall with the blue background position.

Tool Box Screen

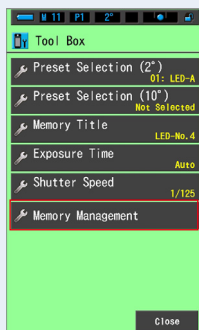

Memory Management Screen

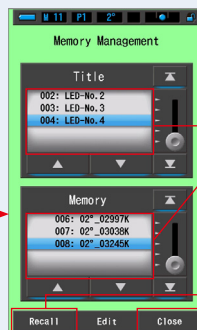

Move Title and then Memory number into the blue background to make a selection.

[Recall] Button
[Close] Button

3. Touch the [Recall] button.

The meter will display the Display Mode viewed at the time the light source was memorized.

To return to the Tool Box screen without confirming, touch the [Close] button.

4. View the memory contents.

The Display Mode at the time the measurement button was pressed appears. In Memory Recall Mode, the background color becomes green.

Memory Title of recalled value appears every two seconds on the status bar.

Ex.)

Memory Recall Mode Spectrum Screen

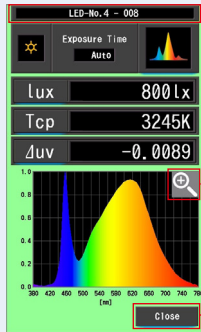

Spectrum Distribution Graph Enlarged Display

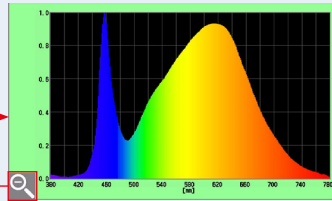

[Close] Button

NOTICE

- If the Memory Button is pressed while in Spectrum Comparison mode, recalled data will be displayed on the Spectrum Display screen.
- In Memory Recall Mode, measurement cannot be made.

5. Touch the [Close] button.

Returns to the Memory Management screen.

Changing Memory Recall Mode Display

Touch one of the [Display Mode] icons in Memory Recall Mode, and the specified display with memorized data for that Memory Recall Mode will appear. In Memory Recall Mode, Memory Title of recalled value appears every two seconds on the status bar.

Memory Recall Mode Display Mode Selection Screen (2°)

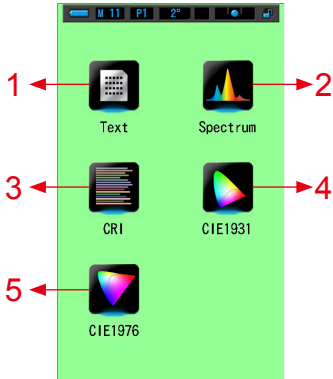

1 Memory Recall Mode Text Mode



2 Memory Recall Mode Spectrum Mode

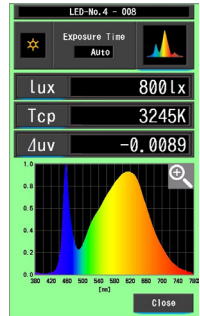

3 Memory Recall Mode CRI Mode

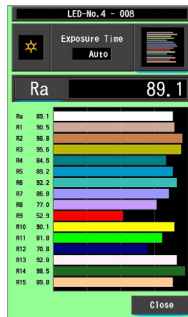

4 Memory Recall Mode CIE1931 (CIE1964) Mode

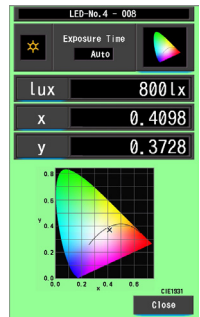



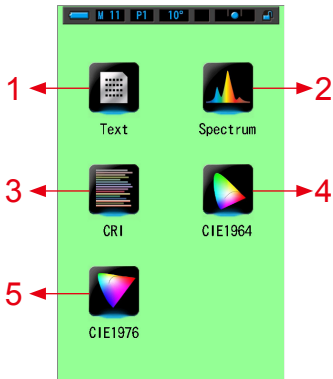

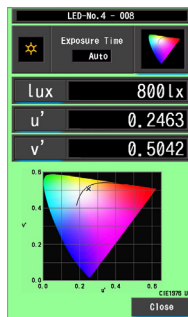

Memory Recall Mode Display Mode Selection Screen (10°)



5 Memory Recall Mode CIE1976 Mode



| No. | Display Mode Icon | Part Name | Description | |
|-----|---|--|--|---|
| 1 |  Text | Memory Recall Mode [Text] Icon | Displays user-selected 5 items in numeric values. (➔ P32) | |
| 2 |  Spectrum | Memory Recall Mode [Spectrum] Icon | Displays 3 user-selected values and spectrum distribution graph. (➔ P35) | |
| 3 |  CRI | Memory Recall Mode [CRI] Icon | Displays the selected average CRI (RA) or individual CRI (R1 ~ R15). Each CRI is displayed in a bar graph. (➔ P43) | |
| 4 |  CIE1931 |  CIE1964 | Memory Recall Mode [CIE1931 (CIE1964)] Icon | Displays the measured result of the selected memory on the CIE1931 chromaticity diagram for a 2° viewing angle (or CIE1964 chromaticity diagram for a 10° viewing angle). (➔ P46) |
| 5 |  CIE1976 | Memory Recall Mode [CIE1976] Icon | Displays the measured result of the selected memory on the CIE1976 chromaticity diagram. (➔ P48) | |

**NOTE**

Memorized data displayed in the various Memory Recall Modes can be selected and changed just as is done in normal, non-memory operation.

Operation

1. Touch the [Display Mode] icon.

The Memory Recall Display Mode Selection Screen will appear.

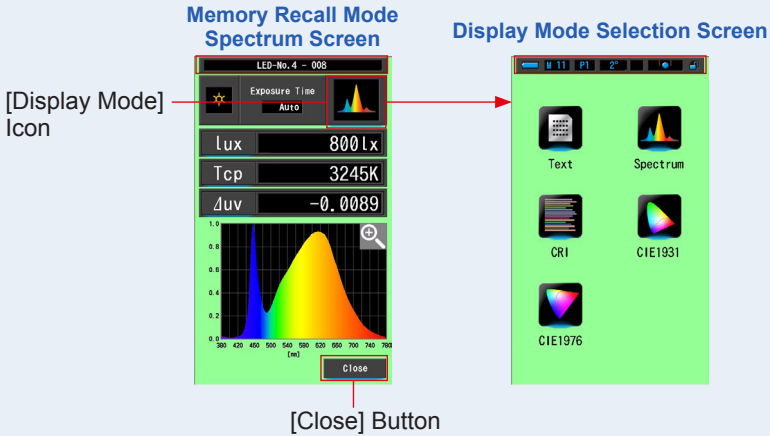

2. Touch the desired [Display Mode] icon to select display.

Switches to selected Display Mode Screen.

Memory Recall Mode Text Mode



3. Touch the [Close] button.

Returns to the Memory Management screen.

6-2-3

Renaming Memory Title [Memory Rename] Screen

The title of measurements of the memory can be changed.

Memory Rename Screen

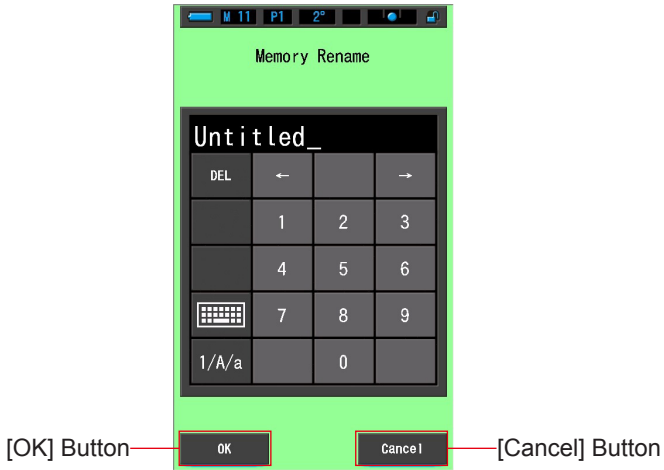

Operation

1. Touch the [Memory Management] button in the Tool Box.
Memory Management screen will be displayed.

Tool Box Screen

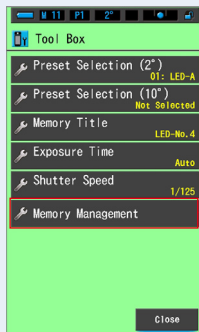

Memory Management Screen

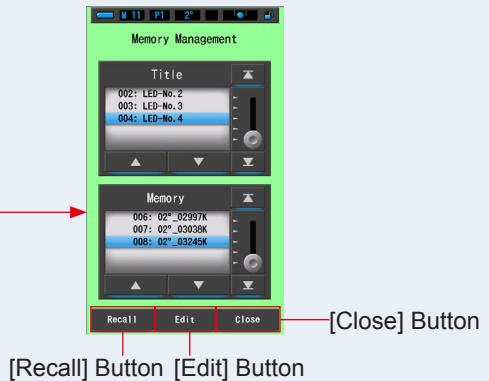

2. Touch the [Edit] button.

Memory Edit screen will be displayed.

Memory Management Screen



[Edit]
Button

Memory Edit Screen

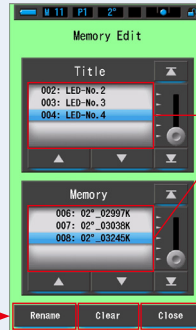

Move Title and then Memory number into the blue background to make a selection.

[Close] Button

[Rename] Button [Clear] Button

3. Select the "Title" and "Memory" to rename with the blue background positions.

4. Touch the [Rename] button.

Memory Rename screen will be displayed.

Memory Edit Screen



[Rename]
Button

Memory Rename Screen



5. Enter the Memory Title to rename. (→ P19)

Use the keyboard to create a name for the memorized value.

Memory Rename Screen

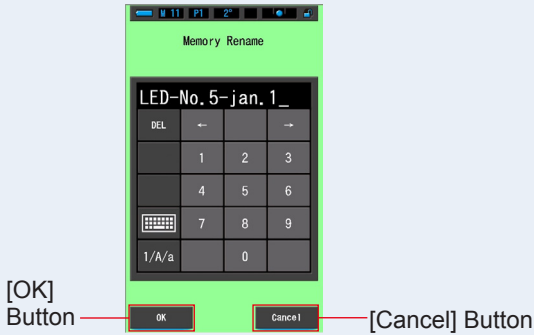

6. Touch the [OK] button.

Confirm and return to the Memory Edit screen.

To return to the Memory Edit screen without confirming, touch the [Cancel] button.

The memory title is entered.

7. Touch the [Close] button.

Close and return to the Memory Management screen. Touch the [Close] button to return to Measuring screen.

Memory Edit Screen

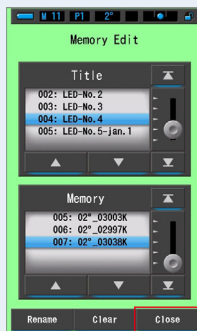

Memory Management Screen

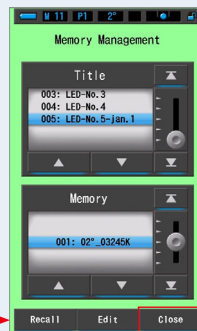

[Close] Button

[Close] Button

6-2-4 Deleting Memorized Value [Memory Clear] Screen

Memorize measurement values can be deleted individually or all at once. In Memory Clear mode, user created Titles and Memory contents (memory numbers and measured values) are displayed in numerical order.

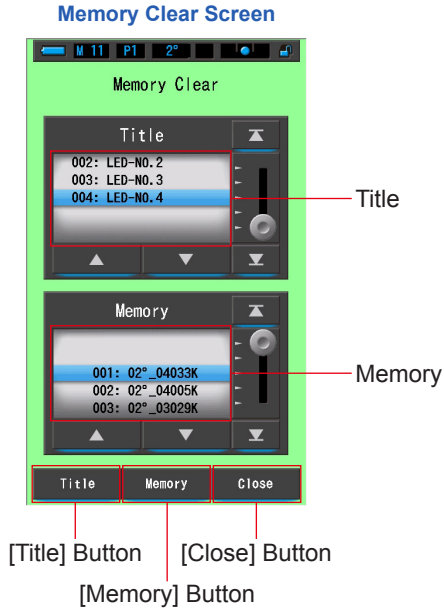

Operation

1. Touch and select the [Memory Management] button in the Tool Box.
The Memory Management screen will be displayed.

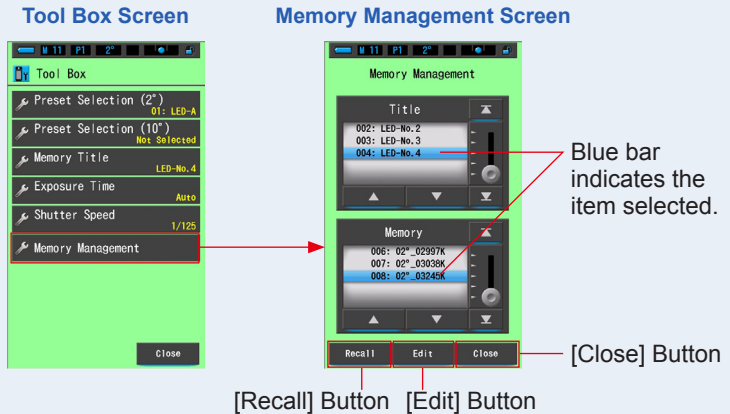

2. Touch the [Edit] button.
Memory Edit screen will be displayed.

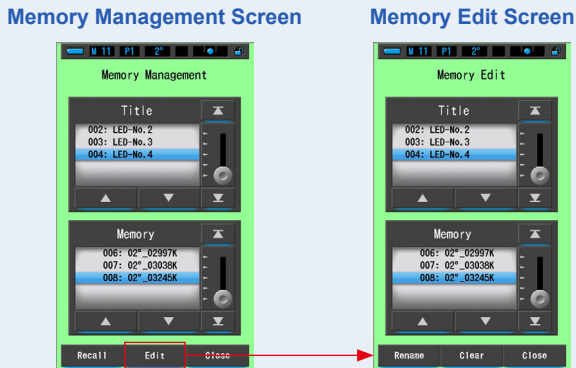

3. Select the "Title" and "Memory" to clear with the blue background positions.

4. Touch the [Clear] button.

Memory Clear screen will be displayed.

Memory Edit Screen



[Clear] Button

Memory Clear Screen

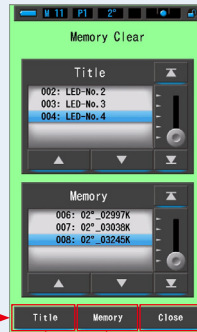

[Title] Button [Memory] Button

[Close] Button

[Erasing Individual Values]

1. Select the Title to display the memorized value you want to delete. Then select the specific light source value under that title, if more than one value has been memorized.

2. Touch the [Memory] button.

This will display the Memory Clear Confirmation screen. "Remove the selected memory data. Are you sure?" will be displayed.

Memory Clear Screen

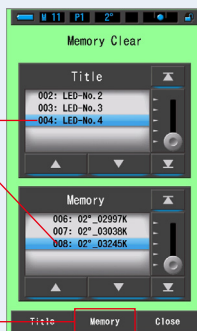

Select Title then the Memory that you want to clear.

[Memory] Button

Memory Clear Confirmation Screen



[Yes] Button

[No] Button

3. Touch the [Yes] button.

A progress bar will appear while the memory is being deleted.

When the memory has been cleared, the meter will return to the Memory Clear Screen.

Additional Memory data can be cleared by repeating steps 1-4.

Touch [No] if you do not wish to clear the Memory data.

Memory Clear Processing Screen

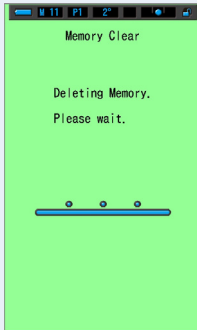

Memory Clear Screen

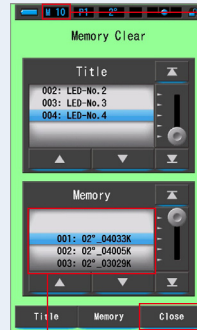

The number of memories will change.

[Close] Button

The selected memory will be deleted, and the numbers after the selected number will decrease by one.

4. Touch the [Close] button.

Returns to the Memory Edit screen.

When you do not delete other memories, touch the [Close] button. This returns to the Memory Edit screen.

[Erasing All]

1. Match the "Title" to be deleted with the blue background positions.

Select the "Title" to be deleted.

2. Touch the [Title] button.

This will delete the title. All the memory data linked to the title will be deleted.

This will display the Memory Clear Confirmation screen. "Remove the selected memory title. Are you sure?" will be displayed.

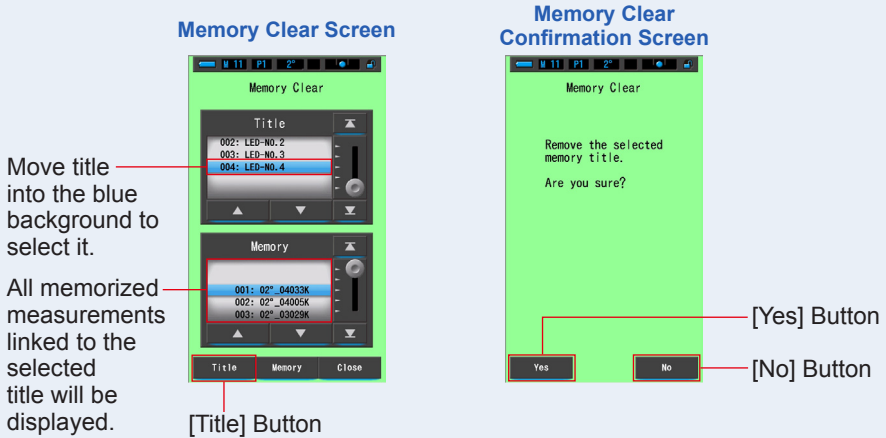

3. Touch the [Yes] button.

"Deleting Memory. Please wait." will be displayed. Returns to the Memory Clear screen after deletion.

While the progress bar is running, the deletion is in progress. The process may require time depending on the number of memories to be deleted. Do not perform other work.

When you do not delete the memories, touch the [No] button to the Memory Clear screen.

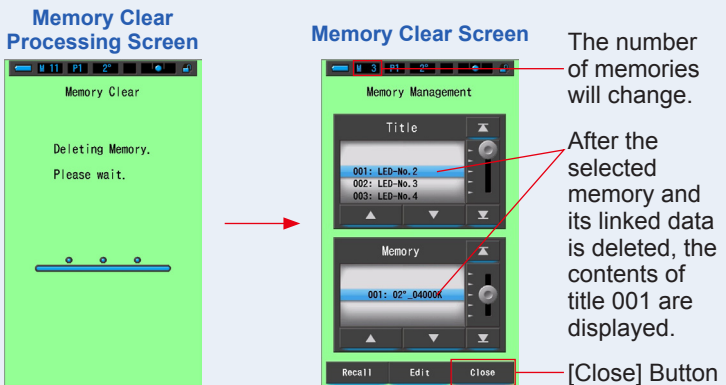

4. Touch the [Close] button.

Returns to the Memory Edit screen. Touch the [Close] button until returning to Measuring screen.

6-3

Selecting Exposure Time [Exposure Time] Screen

Set a Exposure Time for ambient measurement.

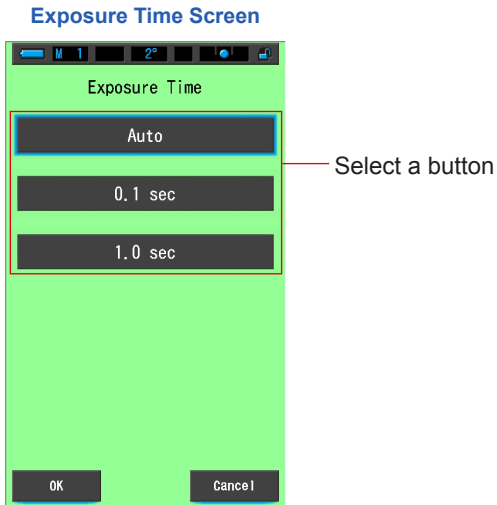

Operation

1. Touch the [Exposure Time] button in the Tool Box.
The Exposure Time screen will be displayed.

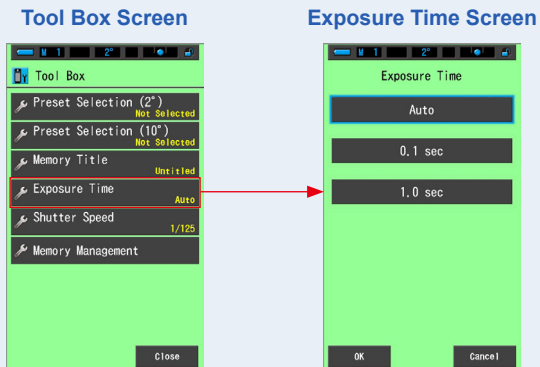

2. Set a Exposure Time for ambient measurement.

Select Auto, 0.1 sec or 1.0 sec.

Exposure Time Screen

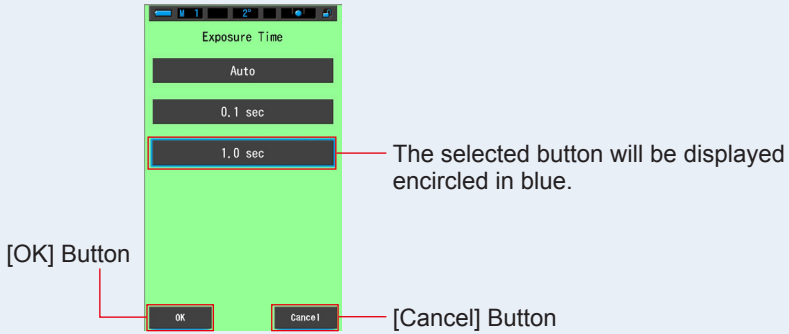

3. Touch the [OK] button.

Confirms and returns to the Tool Box screen.

To return to the Tool Box screen without confirming, touch the [Cancel] button.

The selected status will be displayed on the Tool Box.

Tool Box Screen



The selected exposure time is displayed on the Measurement screen.



The selected exposure time is displayed.

The Exposure Time has been set for a fixed 1.0 second measurement.

NOTE

In Auto mode, the C-7000 automatically selects among 15 measuring times, determined by the illumination available, to achieve a proper result in a convenient way. Two fixed reading times are available to enable exact comparison of multiple measurements.

When measuring high illuminance levels, set the Exposure Time to 0.1 sec. When taking measurements in low illuminance, set the Exposure time for 1.0 sec.

6-4

Setting the Shutter Speed [Shutter Speed] Screen

Set a shutter speed that is appropriate for the intended flash-ambient measurement.

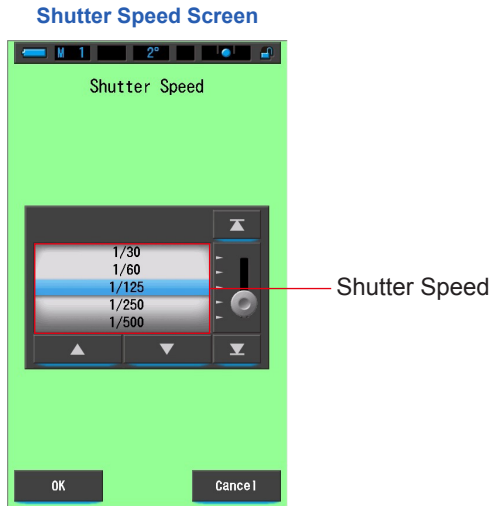

Operation

1. Touch and select the [shutter Speed] button in the Tool Box
The Shutter Speed screen will be displayed.

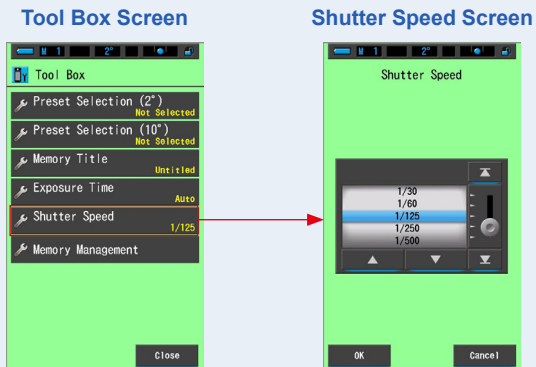

2. Select the desired shutter speed.

Shutter Speed Options (➔ P26)

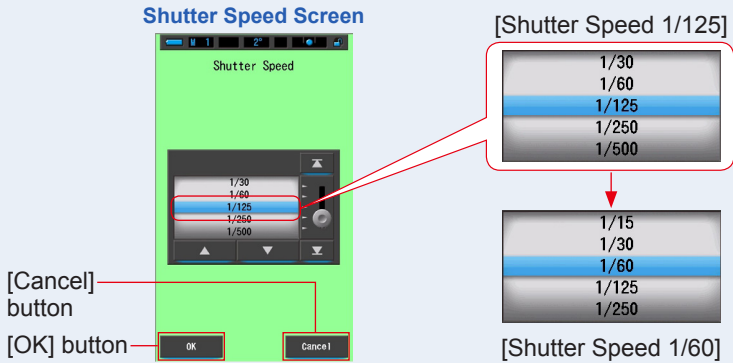

3. Touch the [OK] button.

Confirms the settings, and returns to the previous Measurement screen.

Touch [Cancel] to return to the previous measurement screen without setting speed.

The shutter speed is set.

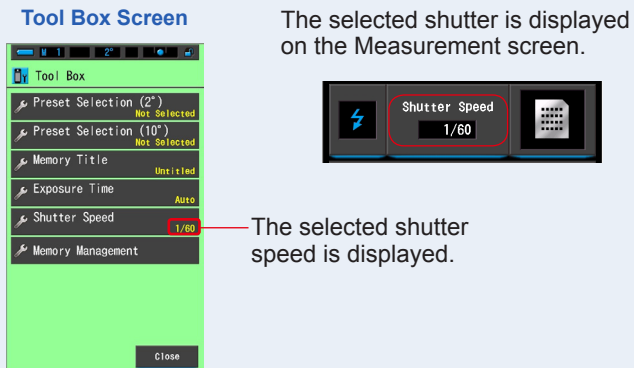

7. Meter Settings [Setting] Screen

7-1 Setting Items

Here you can customize your meter for your preference in advance.

Display Mode Selection Screen

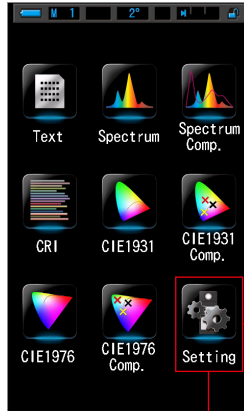

[Setting] Icon

Setting Page 1 Screen

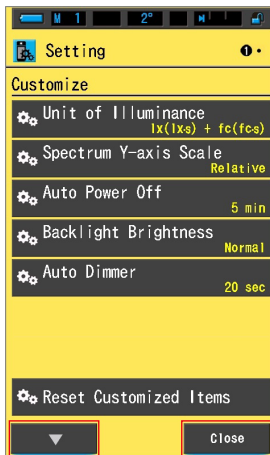

To page 2

Setting Page 2 Screen



To page 1

[Close] Button

* Models sold in some countries do not display illuminance and exposure in "fc (fc-s)" due to legal restrictions.

Operation

1. Touch the [Setting] icon on the Display Mode screen.

Setting will be displayed.

2. Touch the one step icons [▲][▼] to display the desired page.

3. Touch the desired setting name.

That setting screen will be displayed.

When the [Close] button is touched, the display returns to the Display Mode Selection screen.

7-1-1 Item List

The Setting screen items are as follows.

| Item Name | Description |
|--------------------------------|---|
| Customize | |
| Unit of Illuminance | Select the unit from lx(lx·s), fc(fc·s) or both when measuring illuminance. (➡ P110) |
| Spectrum Y-axis Scale | Select relative, auto, or spectral irradiance. (➡ P112) |
| Auto Power Off | Select the time before the power automatically turns off after last use (5min, 10min, 20min, No Auto Power Off). When No Auto Power Off is set, the automatic power OFF function is not activated. (➡ P115) |
| Backlight Brightness | Select the LCD backlight brightness from dark, normal, or bright. (➡ P117) |
| Auto Dimmer | Select the time before the backlight dims after last use to save power or adjust the visibility under the surrounding light condition. (5sec, 10sec, 20sec, 40sec, 60sec, No Dimmer) (➡ P119) |
| Reset Customized Items | Initialize (reset) only contents of "Customize" in Setting to the factory default (5 items for C-7000). (➡ P121) |
| Edit a preset | |
| Preset Editing | Edit a preset for 2° or 10° separately. (➡ P122) |
| Dark Calibration | |
| Dark Calibration | Perform dark calibration. (➡ P146) |
| Display the information | |
| Product Information | Display the product Information. (➡ P149) |
| Regulation | Display the compliant regulation. |

* Models sold in some countries do not display illuminance and exposure in "fc (fc·s)" due to legal restrictions.

7-2 Customize

The meter can be customized to desired measuring and display preferences. The current setting for each item is displayed in yellow letters.

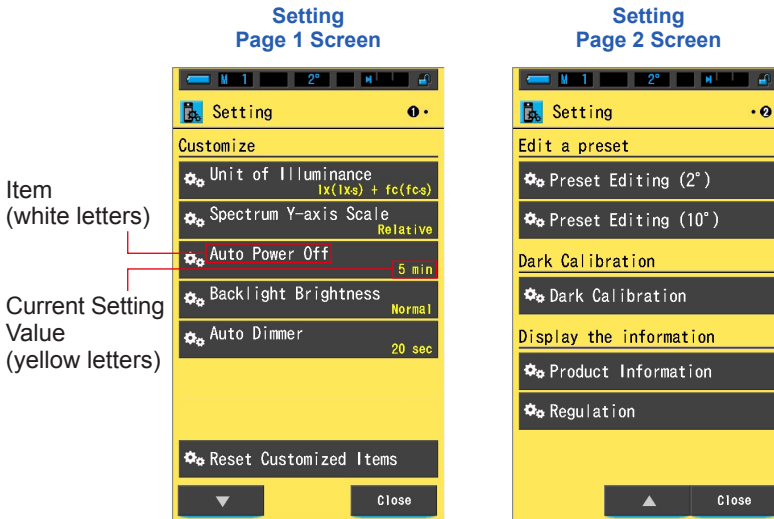

Operation

1. Touch the [Setting] icon on the Display Mode screen.
Setting will be displayed.
2. Touch the one step icons [▲][▼] to display the desired page.
3. Touch the desired item.
The item screen will be displayed.
When the [Close] button is touched, the display returns to the Display Mode Selection screen.

7-2-1 Item Specifications

The specifications of each "Customize" item is as follows.

| No. | Setting Name | Item | | | | | | (Default) |
|-----|-------------------------------|--|----------|---|----------------------|-------|--------------|-----------------------|
| 1 | Unit of Illuminance* | lx(lx·s)+ fc(fc·s) | lx(lx·s) | fc(fc·s) | - | - | - | lx(lx·s)+ fc(fc·s) |
| 2 | Spectrum Y-axis Scale | Relative | Auto | Spectral Radiant Intensity 1.0μW to 100W·m ⁻² ·nm ⁻¹ | | | | Relative |
| 3 | Auto Power Off | 5min | 10min | 20min | No Auto Power Off | - | - | 5min |
| 4 | Backlight Brightness | Dark | Normal | Bright | - | - | - | Normal |
| 5 | Auto Dimmer | 5sec | 10sec | 20sec | 40sec | 60sec | No Dimmer | 20sec |
| 6 | Reset Customized Items | When you touch the [OK] button, the Setting contents will be reset to factory default. | | | | | | - |

* Models sold in some countries do not display illuminance and exposure in "fc (fc·s)" due to legal restrictions.

7-2-2

Selecting the Unit of Illuminance

Select the unit when measuring illuminance.

* Models sold in some countries do not display illuminance and exposure in "fc (fc·s)" due to legal restrictions. In this case, "Unit of Illuminance" button will not appear in Setting screen.

Unit of Illuminance Screen

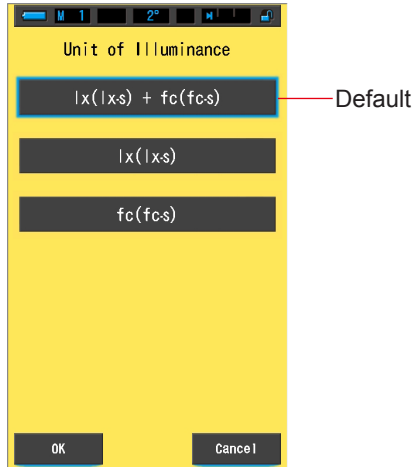

Operation

1. Touch the item [Unit of Illuminance] button on page 1 of Setting screen.

The unit of illuminance will be displayed.

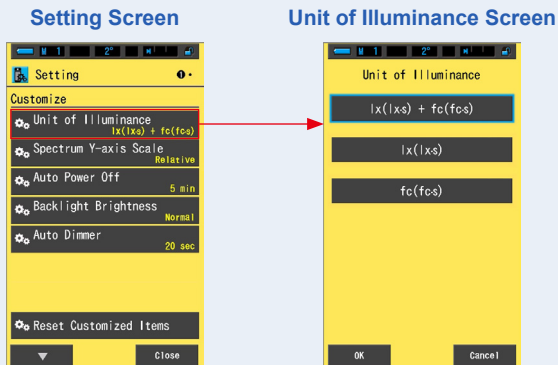

2. Touch the [Unit of Illuminance] button.

Select the unit of illuminance.

Unit of Illuminance Screen

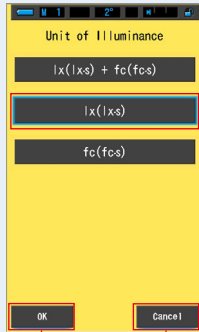

The selected button will be displayed encircled in blue.

[OK] Button

[Cancel] Button

3. Touch the [OK] button.

Confirms the settings, and returns to Setting screen.

To return to the Setting screen without confirming, touch the [Cancel] button.

Setting Screen

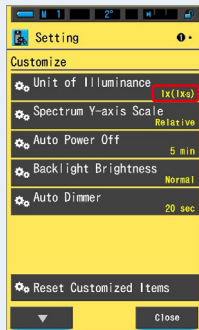

The set content is displayed.

The unit of illuminance is set.

7-2-3

Selecting the Spectrum Y-axis Scale

Select Relative, Auto, or any specific number of spectral irradiance as the maximum display value for the spectrum Y-axis.

Spectrum Y-axis Scale Screen

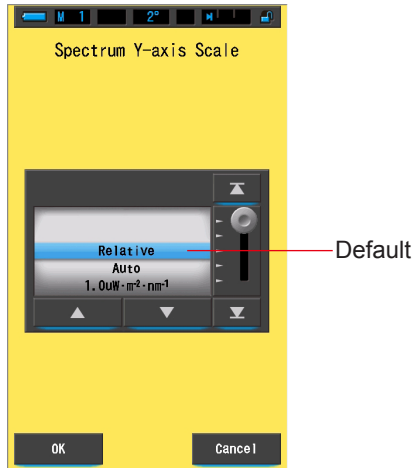

Operation

1. Touch the item [Spectrum Y-axis Scale] button on page 1 of Setting screen.

The maximum display value of the spectrum Y-axis scale will be displayed.

Setting Screen

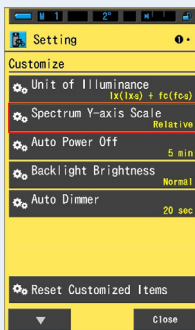

Spectrum Y-axis Scale Screen

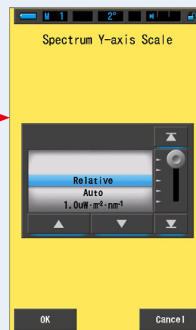

2. Select the desired spectrum Y-axis scale.

Select from Relative, Auto, or any specific number of spectral irradiance.

Spectrum Y-axis Scale Screen

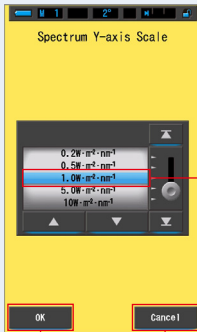

Blue bar indicates the value selected.

[OK] Button

[Cancel] Button

3. Touch the [OK] button.

Confirms the setting, and returns to Setting screen.

To return to the Setting screen without confirming, touch the [Cancel] button.

Setting Screen

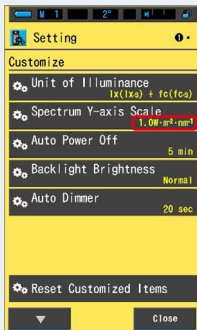

The set content is displayed.

The spectrum Y-axis scale is set.



- Relative.....Regardless of brightness of light source, the peak of brightness in each measurement and memorized values is regarded as 1.0 to compare the light sources in shape of spectrum graph.
- Auto The appropriate Y-axis value is automatically selected and spectral irradiance can be compared.
- Spectral IrradianceSpecific value can be selected from 1.0u to 100 W·m⁻²·nm⁻¹.

Relative

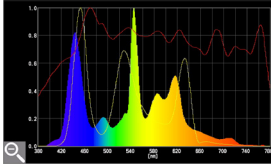

Auto

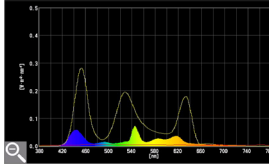

Spectral Irradiance

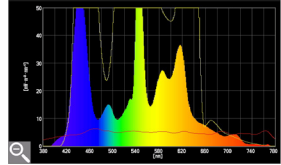

7-2-4

Selecting the Auto Power Off Time

Select the time delay before the power automatically turns off after last use (5min, 10min, 20min, No Auto Power Off). When No Auto Power Off is set, the automatic power OFF function is not activated.

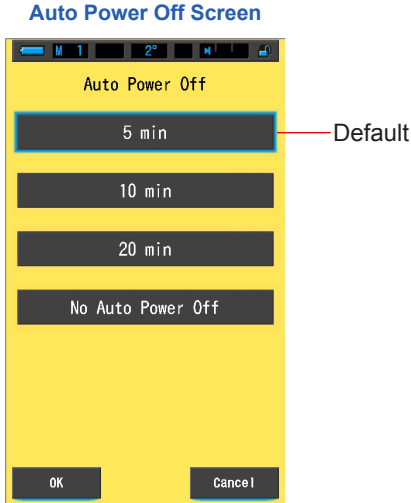

Operation

1. Touch the item [Auto Power Off] button on page 1 of Setting screen.

The auto power off time will be displayed.

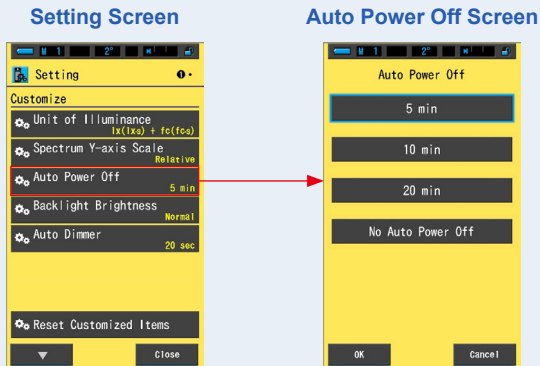

2. Touch the desired time delay button on the Auto Power Off screen.

Select 5min, 10min, 20min, or No Auto Power Off.

Auto Power Off Screen

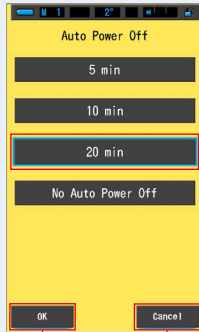

The selected button will be displayed encircled in blue.

[OK] Button

[Cancel] Button

3. Touch the [OK] button.

Confirms the settings, and returns to Setting screen.

To return to the Setting screen without confirming, touch the [Cancel] button.

Setting Screen

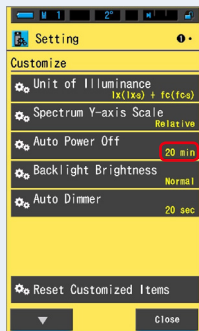

The set content is displayed.

The auto power off time delay is set.

7-2-5

Selecting the Backlight Brightness

Select the LCD backlight brightness from Dark, Normal or Bright to extend battery life or adjust the visibility under the surrounding light conditions.

Backlight Brightness Screen

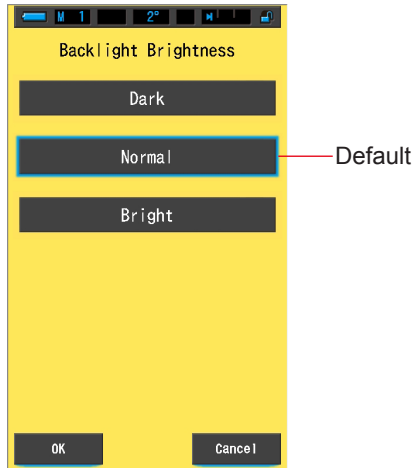

Operation

1. Touch the item [Backlight Brightness] button on page 1 of Setting screen.

The Backlight Brightness screen will be displayed.

Setting Screen



Backlight Brightness Screen

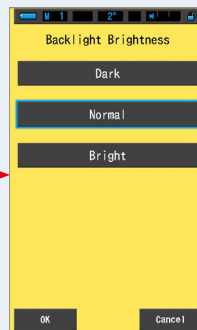

2. Touch the desired brightness button on the Backlight Brightness screen.

Select Dark, Normal or Bright.

Backlight Brightness Screen

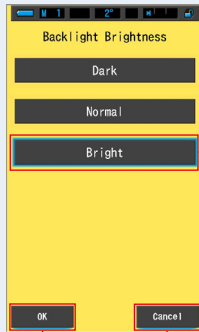

The selected button will be displayed encircled in blue.

[OK] Button

[Cancel] Button

3. Touch the [OK] button.

Confirms the settings, and returns to Setting screen.

To return to the Setting screen without confirming, touch the [Cancel] button.

Setting Screen

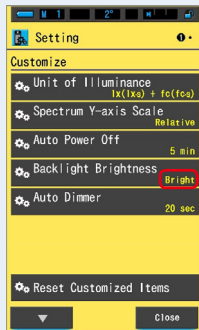

The set content is displayed.

The backlight brightness level is set.

7-2-6

Selecting the Auto Dimmer Time

Select the time delay before the backlight dims after last use to extend battery life or adjust the visibility under the surrounding light condition.
(5sec, 10sec, 20sec, 40sec, 60sec, No Dimmer)

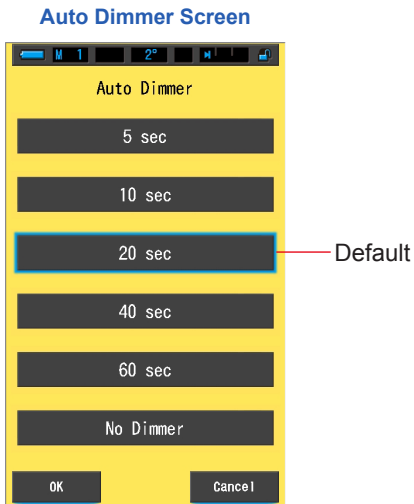

Operation

1. Touch the [Auto Dimmer] button on page 1 of Setting screen
The auto dimmer time delays will be displayed.

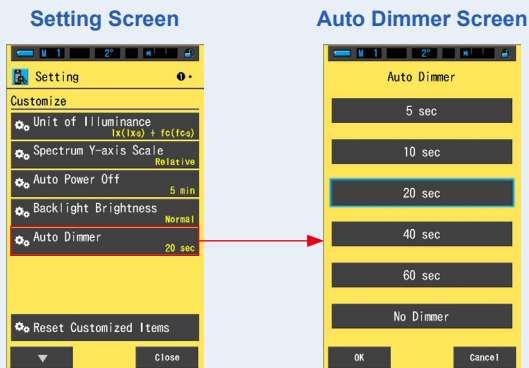

- 2. Touch the desired time delay button on the Auto Dimmer screen.**
Select 5sec, 10sec, 20sec, 40sec, 60sec, or No Dimmer.

Auto Dimmer Screen

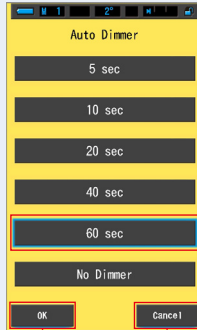

The selected button will be displayed encircled in blue.

[OK] Button [Cancel] Button

- 3. Touch the [OK] button.**

Confirms the settings, and returns to Setting screen.

To return to the Setting screen without confirming, touch the [Cancel] button.

Setting Screen



The set content is displayed.

The auto dimmer time delay is set.

7-2-7

Reset Customized Items

This resets the user-set items in "Customize" lists of Setting to the factory default settings.

Reset Customized Items Screen

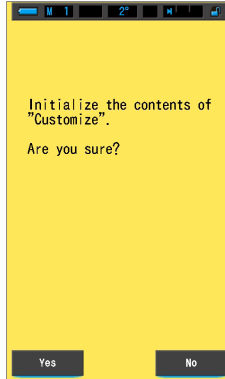

Operation

1. Touch the item [Reset Customized Items] button on page 1 of Setting screen.

"Initialize the contents of "Customize". Are you sure?" is displayed.

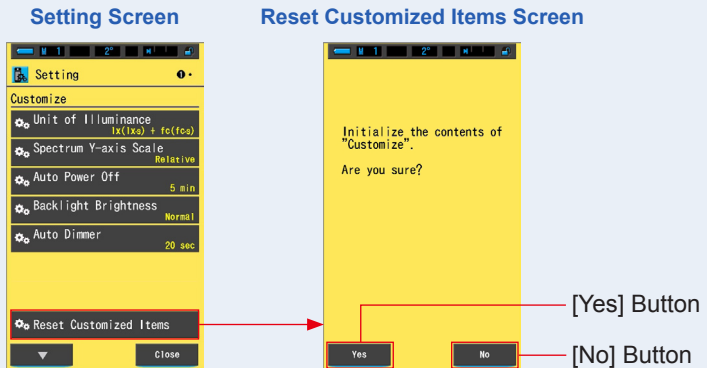

2. Touch the [Yes] button.

After internalization is finished, custom settings are default and the display returns to the Setting screen.

To return to the Setting screen without initializing, touch the [No] button.

7-3 Preset Editing

Select [Preset Editing (2°)] button or [Preset Editing (10°)] button.

Preset value is used for the reference value in Monitor Function.

This preset reference value can be input manually or set from memorized value if there is data in meter's memory.

Refer to page 159 for details on Field of View (2 degrees and 10 degrees).

Preset Editing Screen
(Page 1)

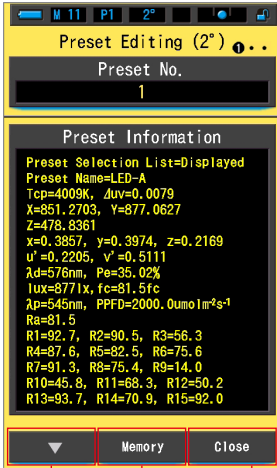

To page 2

[Memory] Button

Preset Editing Screen
(Page 2)



To page 3

To page 1

[Close] Button

Preset Editing Screen
(Page 3)

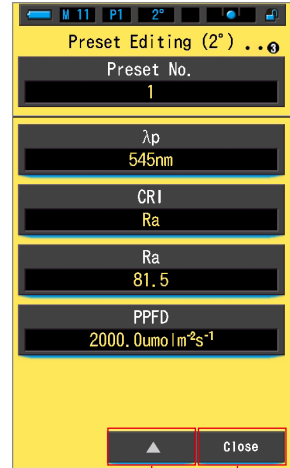

To page 2

* If no value is stored in memory, the [Memory] button is not activated.



NOTE

Up to 5 presets can be registered for each of viewing angle 2° and 10°.

Operation

1. Touch the item [Preset Editing (2°)] or [Preset Editing (10°)] button on page 2 of Setting screen.

The Preset Editing screen of Setting will be displayed.

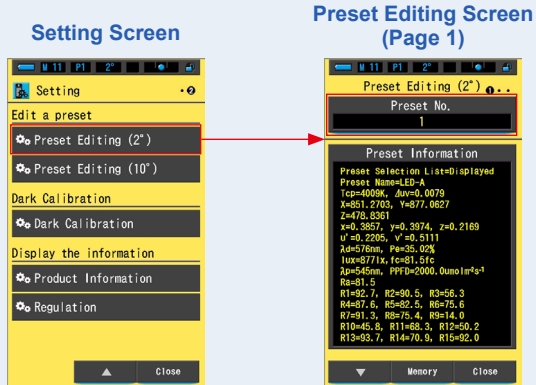

2. Touch the [Preset No.] button on page 1 of [Preset Editing (2°)] or [Preset Editing (10°)].

The Preset Number screen is displayed.

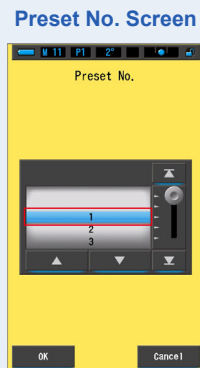

3. Select the desired present number (1 ~ 5) to edit. Adjust it to the blue background position.

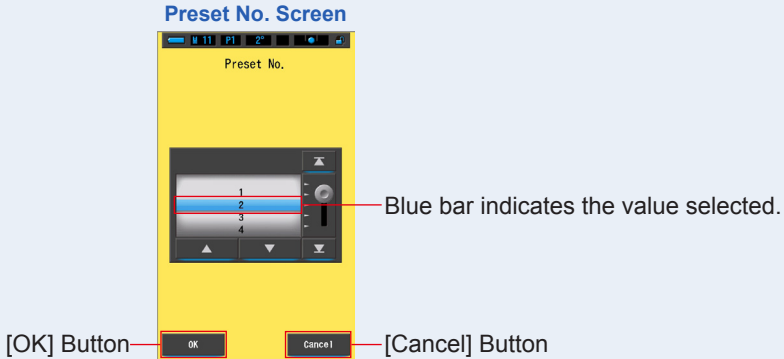

4. Touch the [OK] button.

Preset number is confirmed and the display returns to page 1 of the Preset Editing (2°)/(10°) screen.

To return to the page 1 of the Preset Editing (2°)/(10°) screen without confirming, touch the [Cancel] button.

Preset Editing Screen (Page 1)

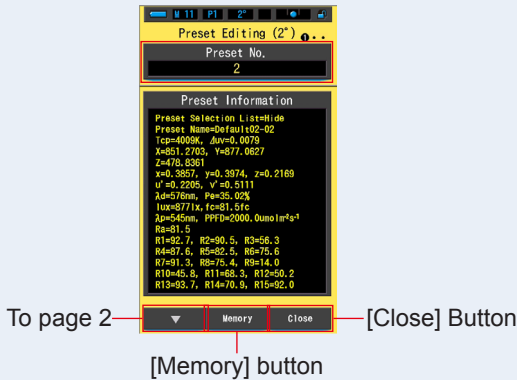

[Setting the preset value from memorized value]

1. Touch the [Memory] button on the page 1 of Preset Editing screen.

Memory Recall screen is displayed.

Preset Editing Screen
(Page 1)

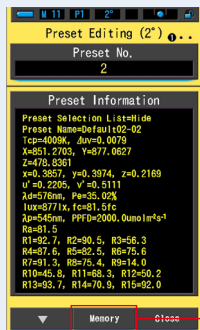

[Memory] button

Memory Recall Screen
in Preset Editing

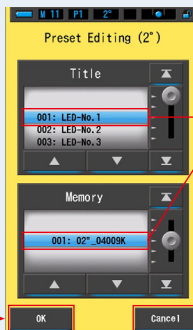

[OK] button

[Cancel] button

The selected memory will be displayed encircled in blue.

2. Select the memorized value to set.

The selected memory will be displayed encircled in blue.

Memory Recall Screen in Preset Editing

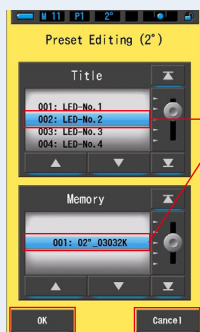

[OK] button

[Cancel] button

The selected memory will be displayed encircled in blue.



3. Touch the [OK] button.

The selected memory is set as preset information and the display returns to page 1 of the Preset Editing (2°)/(10°).

To return to the page 1 of the Preset Editing (2°)/(10°) screen without confirming, touch the [Cancel] button.

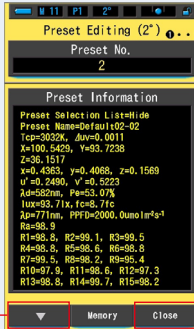
Preset Editing Screen (Page 1)



To page 2  Memory  [Close] button

4. Touch the [Close] button.

Returns to Setting screen.



[Setting the preset value manually]

1. Edit each setting item.

Touch the down arrow to go to page 2 and page 3 where item can be edited.

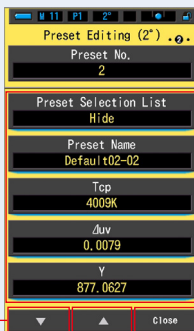
Preset Editing Screen (Page 2)



To page 3   To page 1  [Close] Button

Preset Editing Screen (Page 3)

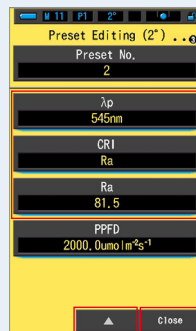

To page 2  [Close] Button

Refer to the following pages for editing each setting item.

- Preset Selection List (➔ P128)
- T_{cp} (Correlated Color temperature) (➔ P132)
- Y (tristimulus value) (➔ P136)
- CRI (Color Rendering Index) (➔ P140)
- PPF_D (Photosynthetic Photon Flux Density) (➔ P144)
- Preset Name (➔ P130)
- Δ uv (deviation) (➔ P134)
- λ p (peak wavelength) (➔ P138)
- Ra (Average CRI) (➔ P142)

2. Touch the [Close] button.

Returns to Setting screen.

3. Preset information can be viewed.

After editing the Preset settings, review and check the data on page 1 of Preset Editing.

Preset Editing Screen (Page 1)

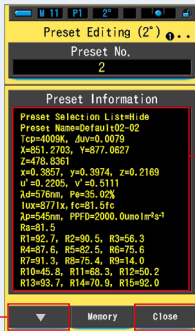

Preset information display

To page 2

[Close] Button

7-3-1

Displaying the Preset Selection List

Choose to display or hide Preset Selection list in the Tool Box.

Display in the Preset Selection List Screen

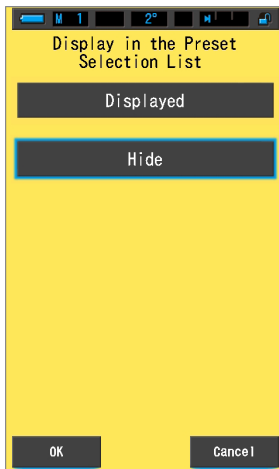

Operation

1. Touch the [Preset Selection List] button on page 2 of Preset Editing (2°) or Preset Editing (10°).

Display in the Preset Selection List will appear.

Preset Editing Screen
(Page 2)

Display in the Preset Selection List Screen

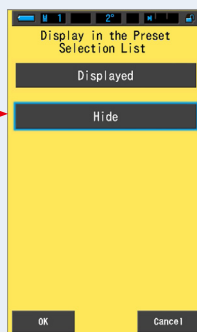

2. Select the [Displayed] to set.

The selected icon will be displayed encircled in blue.

Display in the Preset Selection List Screen

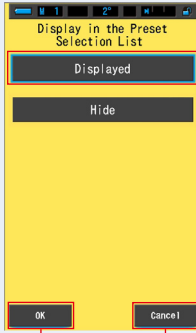

The selected button will be displayed encircled in blue.

[OK] Button [Cancel] Button

3. Touch the [OK] button.

The set item is confirmed, and the display returns to page 2 of the Preset Editing (2°)/(10°) screen.

To return to the page 2 of the Preset Editing (2°)/(10°) screen without confirming, touch the [Cancel] button.

Preset Editing Screen (Page 2)

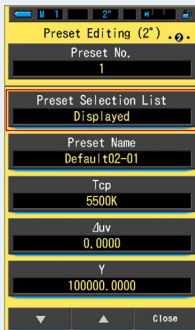

The Preset Selection List is set.



NOTE

The edited preset data will be displayed on the Preset Information screen.

7-3-2 Setting the Present Name

Editing the Preset Name.



NOTE

Up to 16 alphanumeric characters can be input for Preset name.

Operation

1. Touch the [Preset Name] button on page 2 of Preset Editing (2°) or Preset Editing (10°).

The Preset Name Input screen is displayed.

**Preset Editing Screen
(Page 2)**

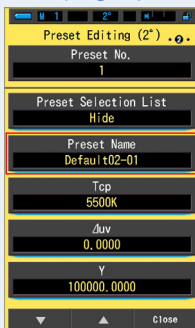

Preset Name Screen

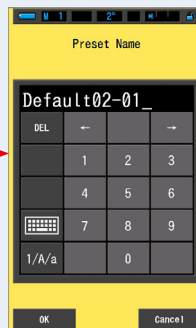

2. Use the keyboard to create a name for the preset. (→ P19)

Preset Name Screen



Input number

Keypad (Upper Case Input Screen)



[OK] Button [Cancel] Button

3. Touch the [OK] button.

The Preset name is memorized, and the display returns to the page 2 of the Preset Editing (2°)/(10°) screen.

To return to the page 2 of the Preset Editing (2°)/(10°) screen without confirming (memorizing/editing), touch the [Cancel] button.

Page 2 Screen (with memory)

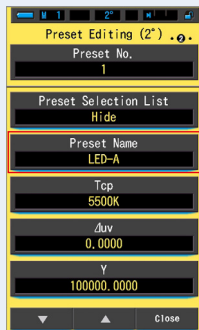

The preset name is entered and memorized.



NOTE

The edited preset data will be displayed on the Preset Information screen.

7-3-3 Setting the Tcp

Set the preset Tcp (Correlated Color Temperature).

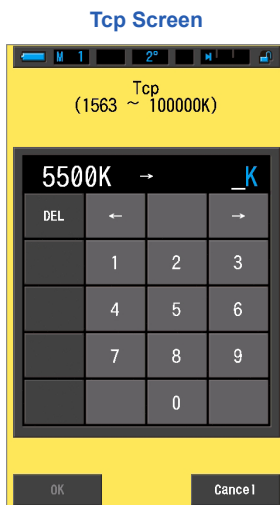

Operation

1. Touch the [Tcp] button on page 2 of Preset Editing (2°) or Preset Editing (10°).

The Tcp Input screen will be displayed.

**Preset Editing Screen
(Page 2)**

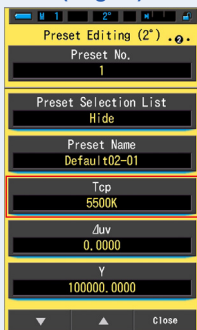

Tcp Screen

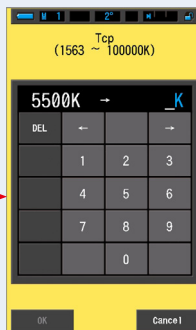

2. Enter the value of the Tcp. (⇒ P19)

Input the Tcp value to be set.

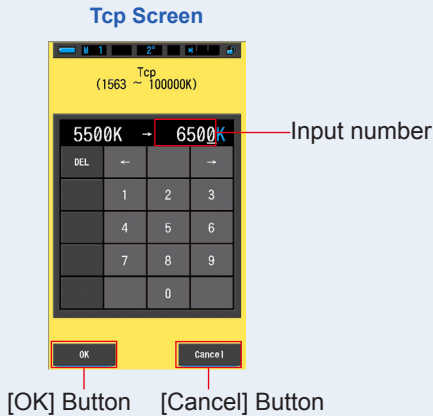

3. Touch the [OK] button.

The number is fixed, and the display returns to the page 2 of the Preset Editing (2°)/(10°) screen.

To return to the page 2 of the Preset Editing (2°)/(10°) screen without confirming, touch the [Cancel] button.

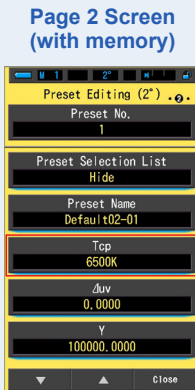

The Tcp (Correlated Color Temperature) is edited.



NOTE

The edited preset data will be displayed on the Preset Information screen.

7-3-4 Setting the Δuv

Sets the preset Δuv (Deviation).

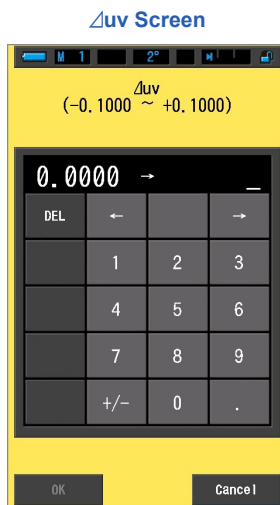

Operation

1. Touch the [Δuv] button on page 2 of Preset Editing (2°) or Preset Editing (10°).

The Δuv input screen will be displayed.

Preset Editing Screen (Page 2)



Δuv Screen

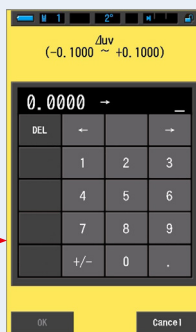

2. Set the deviation value. (→ P19)

If the entered value is within the setting range, the [OK] button is displayed.

If it is outside the set range, re-entred a value.

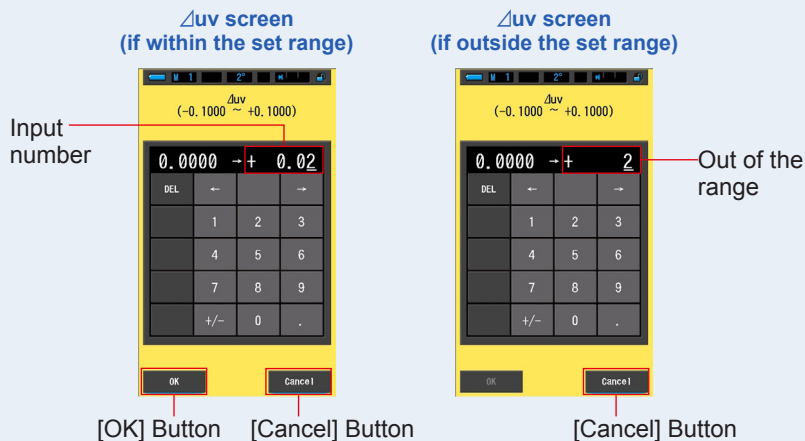

3. Touch the [OK] button.

The number is memorized, and the display returns to the page 2 of the Preset Editing (2°)/(10°) screen.

To return to the page 2 of the Preset Editing (2°)/(10°) screen without confirming, touch the [Cancel] button.

Preset Editing Screen (Page 2)

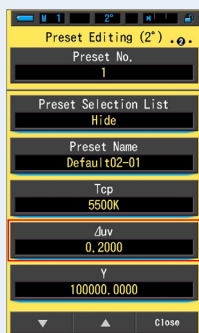

The Δuv (Deviation) is edited.



NOTE

The edited preset data will be displayed on the Preset Information screen.

7-3-5 Setting the Tristimulus Value Y

The preset tristimulus value Y can be set as illuminance (lx).

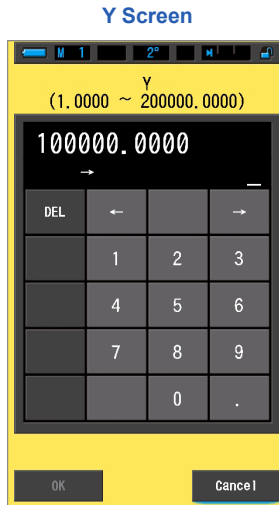

Operation

1. Touch the [Y] button on page 2 of Preset Editing (2°) or Preset Editing (10°).

The tristimulus value Y screen is displayed.

**Preset Editing Screen
(Page 2)**

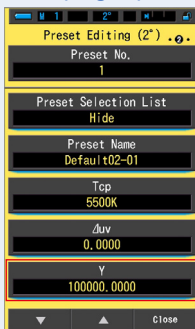

Y Screen



2. Set tristimulus value Y. (⇒ P19)

If the entered value is within the setting range, the [OK] button is displayed.

If it is outside the setting range, re-enter a value.

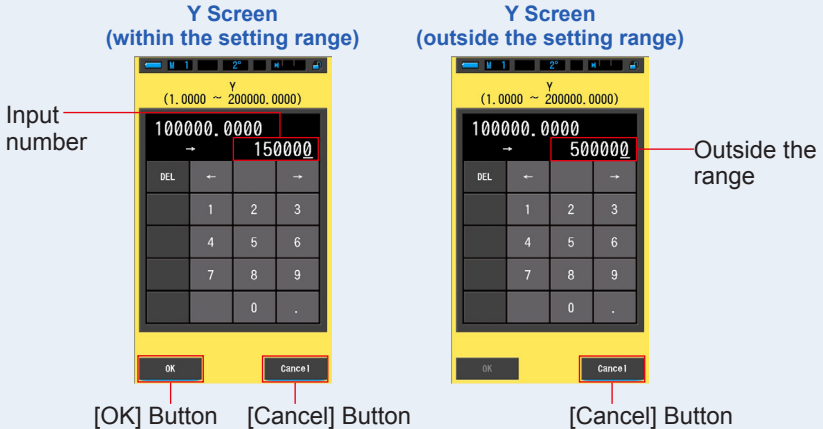

3. Touch the [OK] button.

The number is confirmed and the display returns to the page 2 of the Preset Editing (2°)/(10°) screen.

To return to page 2 of the Preset Editing (2°)/(10°) screen without confirming, touch the [Cancel] button.

Preset Editing Screen (Page 2)

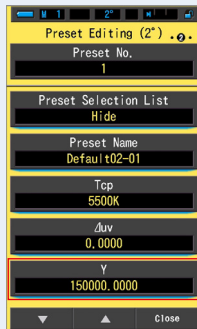

The tristimulus value Y (illuminance (Ix)) is edited.



NOTE

- The edited preset data will be displayed on the Preset Information screen.
- Setting range of tristimulus value Y is 1.0000 to 200,000, although the meter's measuring range of illuminance (Ix) is from 1 to 200,000Ix.

7-3-6 Setting the λ_p

Setting the preset peak wavelength λ_p (Peak wavelength).

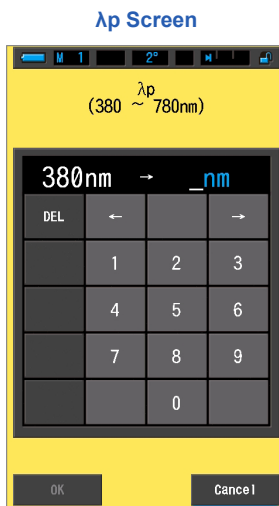

Operation

1. Touch the [λ_p] button on page 3 of Preset Editing (2°) or Preset Editing (10°).

The peak wavelength λ_p screen is displayed.

Preset Editing Screen (Page 3)

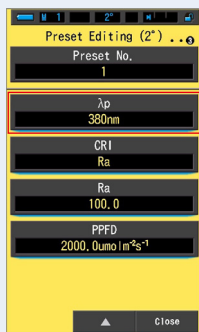

λ_p Screen



- 2. Set the peak wavelength λ_p within the range from 380 to 780 nm. (⇒ P19)**
 If the entered value is within the setting range, the [OK] button is displayed.
 If it is outside the setting range, re-enter a value.

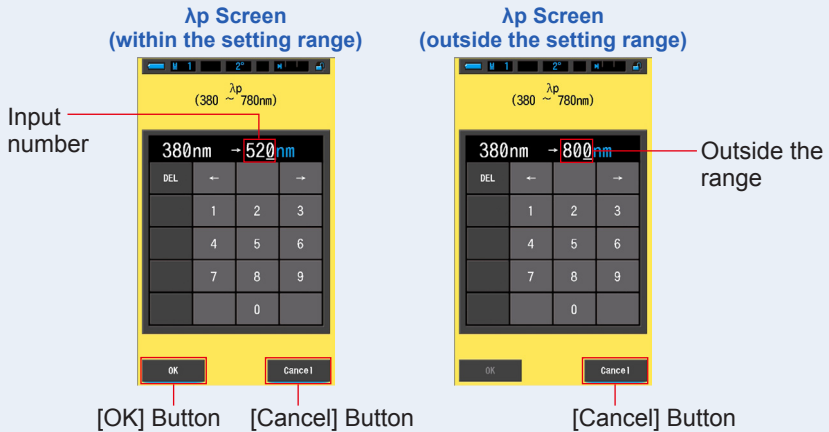

- 3. Touch the [OK] button.**

The number is memorized, and the display returns to the page 3 of the Preset Editing (2°)/(10°) screen.

To return to the page 3 of the Preset Editing (2°)/(10°) screen without confirming, touch the [Cancel] button.

Preset Editing Screen (Page 3)

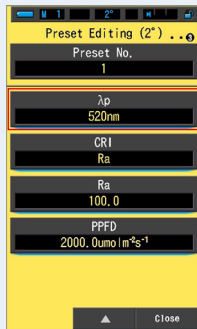

The λ_p (Peak wavelength) is edited.



NOTE

The edited preset data will be displayed on the Preset Information screen.

7-3-7 Setting the CRI

Select the preset CRI (Color Rendering Index: Ra, or R1 to R15).



Operation

1. Touch the [CRI] button on page 3 of Preset Editing (2°) or Preset Editing (10°).

The Color Rendering Index screen is displayed.

**Preset Editing Screen
(Page 3)**

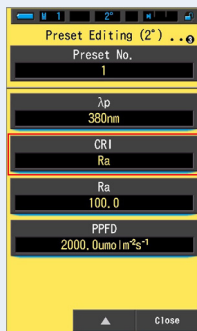

CRI Screen

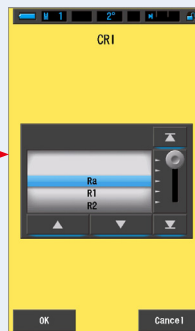

2. Select the desired color rendering index. (→ P18)

Select Ra, or any single index from R1 to R15. Adjust the index under the blue background to select.

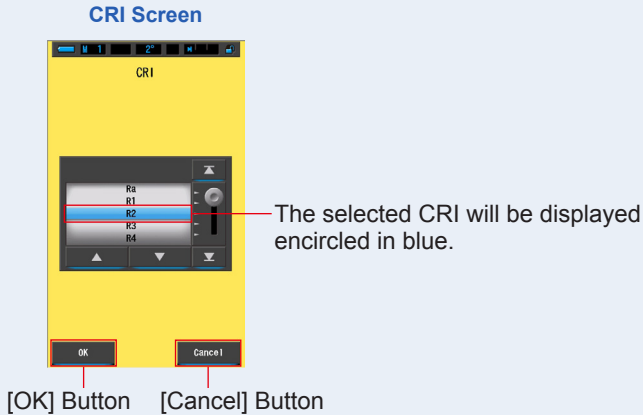

3. Touch the [OK] button.

The set item is memorized, and the display returns to the page 3 of the Preset Editing (2°)/(10°) screen.

To return to the page 3 of the Preset Editing (2°)/(10°) screen without confirming, touch the [Cancel] button.

**Preset Editing Screen
(Page 3)**

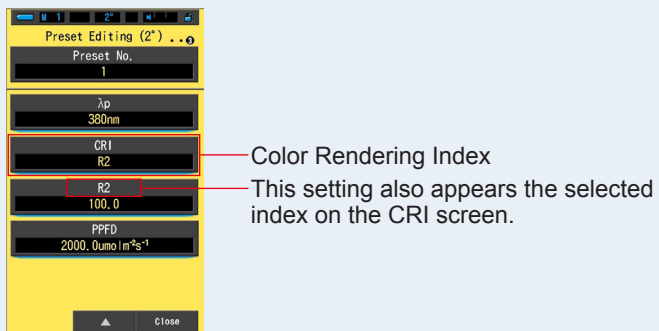

The CRI (Color Rendering Index) is edited.

7-3-8 Setting the value of CRI

Set the preset CRI value for the selected CRI. (➔ P140)

Selected CRI Value Input Screen

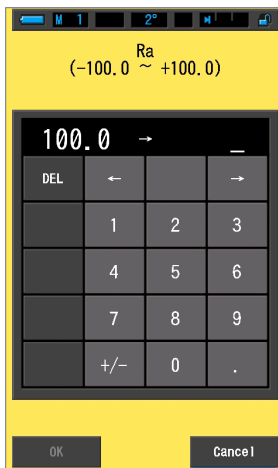

Operation

1. Touch the [Selected CRI Value Input] button on page 3 of Preset Editing (2°) or Preset Editing (10°).

The Selected CRI screen is displayed. (The default is Ra.)

Preset Editing Screen
(Page 3)

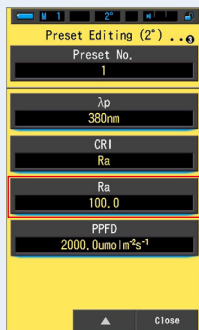

Selected CRI Value Input
Screen

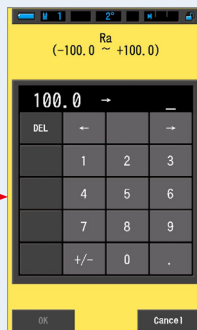

2. Set the value of selected CRI. (⇒ P19)

If the entered value is within the setting range, the [OK] button is displayed.

If it is outside the setting range, re-enter a value.

Selected CRI Value Input Screen
(within the setting range)

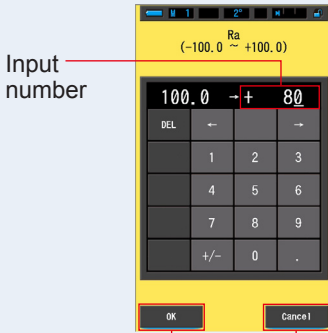

[OK] Button

[Cancel] Button

Selected CRI Value Input Screen
(outside the setting range)



Outside the
range

[Cancel] Button

3. Touch the [OK] button.

The number is memorized, and the display returns to the page 3 of the Preset Editing (2°)/(10°) screen.

To return to the page 3 of the Preset Editing (2°)/(10°) screen without confirming, touch the [Cancel] button.

Preset Editing Screen
(Page 3)

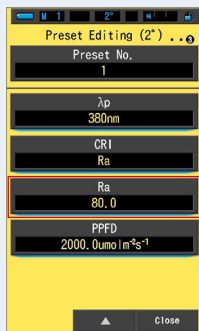

The selected CRI value is edited.

7-3-9

Setting the PPF (Photosynthetic photon flux density)

Setting the PPF (Photosynthetic Photon Flux Density).

PPFD Screen



Operation

1. Touch the [PPFD] button on page 3 of Preset Editing (2°) or Preset Editing (10°).

The PPF (Photosynthetic Photon Flux Density) input screen is displayed.

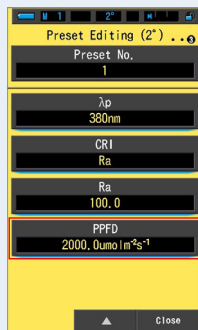
Preset Editing Screen
(Page 3)

PPFD Screen



2. Set the PPFD (Photosynthetic Photon Flux Density) from 0.0 to 9999.9 $\mu\text{mol m}^{-2}\text{s}^{-1}$. (→ P19)

If the entered value is within the setting range, the [OK] button is displayed.

If it is outside the setting range, re-enter a value.

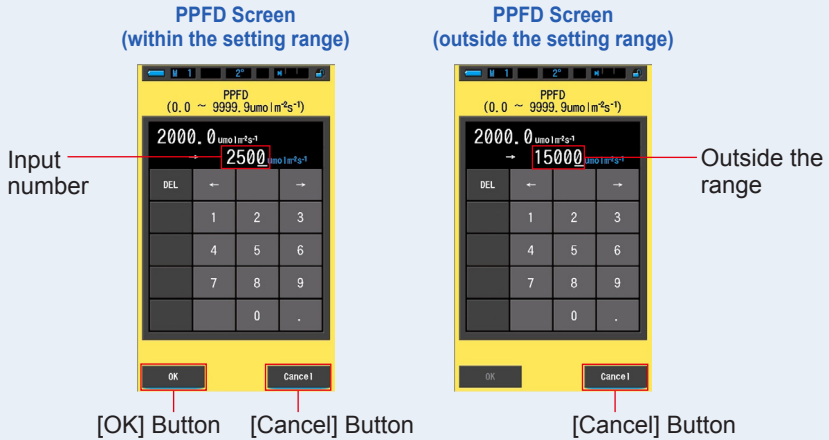

3. Touch the [OK] button.

The number is memorized, and the display returns to the page 3 of the Preset Editing (2°)/(10°) screen.

To return to the page 3 of the Preset Editing (2°)/(10°) screen without confirming, touch the [Cancel] button.

Preset Editing Screen (Page 3)



The PPFD (Photosynthetic Photon Flux Density) is edited.



NOTE

The edited preset data will be displayed on the Preset Information screen.



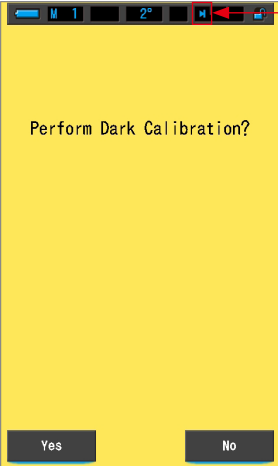

7-4 Dark Calibration

Dark calibration is performed when new batteries are used, 24 hours passed since last use or there is a big change in temperature between turning power OFF and ON again. Except the cases above, dark calibration after power ON is skipped. Accordingly, when there are sudden changes in temperature experienced while using the meter may effect measured values. When temperature changes are encountered, perform dark calibration manually.

Dark Calibration Confirmation Screen



Light Selection Ring Status Indicator Chart

| Icon | | Content |
|---|---|--|
|  |  | If either of icons appears, set the Light Selection Ring ② to the dark calibration position. |
|  |  | |
|  | CAL | This icon is the dark calibration position. Perform dark calibration after making sure it is set to this position. |

Operation

1. Touch the item [Dark Calibration] button on page 2 of Setting.
"Perform Dark Calibration?" will be displayed.

Setting Screen



Dark Calibration Confirmation Screen



2. Turn the Light Selection Ring ② to set to the dark calibration position CAL ().

The status bar will display the dark calibration icon.

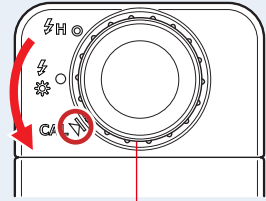
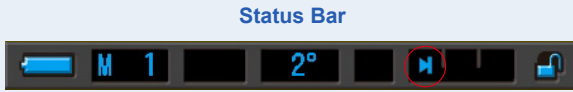

Light Selection Ring ②

3. Touch the [Yes] button.

"Dark calibration in progress. Please wait" and the status bar will appear while meter's measuring system is being calibrated.

To return to Setting without performing dark calibration, touch the [No] button.

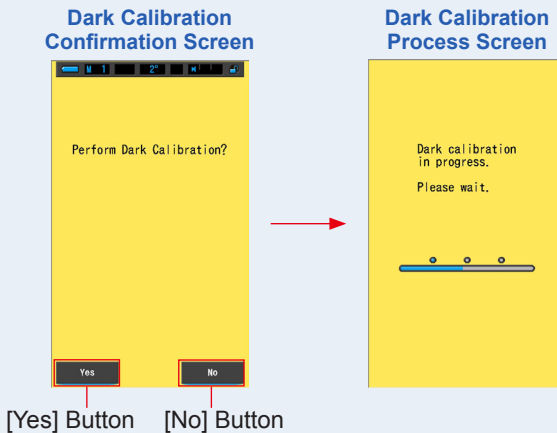

While the message "Dark calibration in progress. Please wait." or the progress bar is displayed, do not turn the power off. Otherwise, the meter may be damaged.

The dark calibration is completed.

When the Following Screen is Displayed

Dark Calibration Position Confirmation Screen



If the Light Selection Ring ② is set to Range H (⚡ H (🔴)) or Range L (⚡ L (🔵)), dark calibration cannot be performed.

Set the Light Selection Ring ② to the dark calibration position **CAL** (⚡ CAL (🔵)), and perform dark calibration.

Dark Calibration Failure Screen

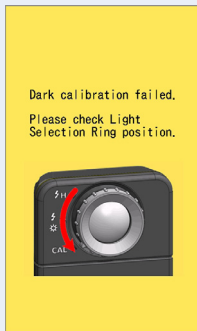

If Dark calibration was performed, but it could not be completed normally.

Set the Light Selection Ring ② to the dark calibration position **CAL** (⚡ CAL (🔵)) again, and perform dark calibration again.

NOTE

- Dark calibration can be done by turning the Light Selection Ring ② to set to the dark calibration position **CAL** (⚡ CAL (🔵)) in Measuring.
- Dark calibration is performed when new batteries are set, 24 hours passed since last use or there is a big change in temperature between turning power OFF and ON again. Except the cases above, dark calibration after power ON is skipped.

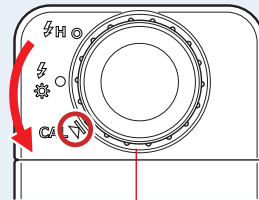

Light Selection Ring ②

7-5 Product Information Display

The Product Information screen displays detailed information not displayed in the Measurement screen.

Product Information Screen

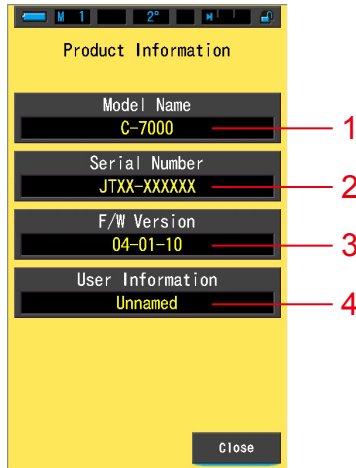

* The screen contents differs depending on model.

| No. | Item Name | Description |
|-----|-------------------------|---|
| 1 | Model Name | Displays the model number of the meter. |
| 2 | Serial Number | Displays the serial number of the meter. |
| 3 | F/W Version | Displays the firmware version. |
| 4 | User Information | Displays user-input information such as ownership or meter function, etc which is set in the "Hardware Setting". (➡ P152) |

Operation

1. Touch the item [Product Information] button on page 2 of Setting.
The Product Information screen will be displayed.

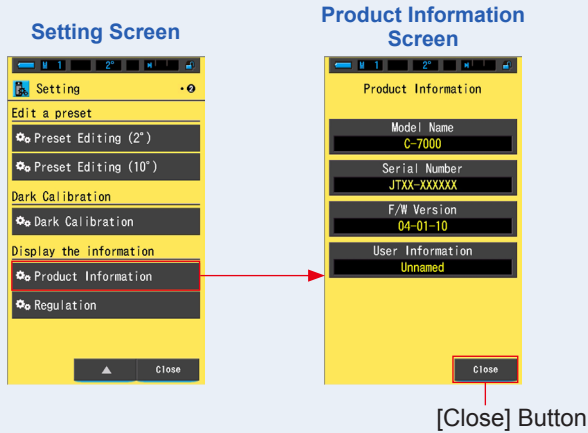

2. Touch the [Close] button.
Returns to Setting.

7-6 Regulation Display

The Regulation screen displays the symbols, approved number, regulation names, etc. which the meter is compliance with

Regulation Screen

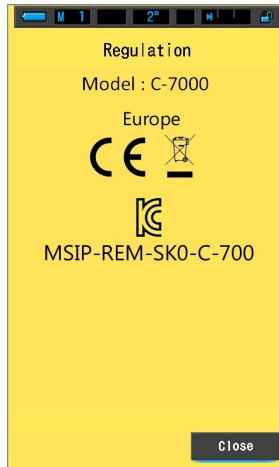

Operation

1. Touch the item [Regulation] button on page 2 of Setting.

The Regulation screen will be displayed.

The display contents will differ depending on the product you have purchased.

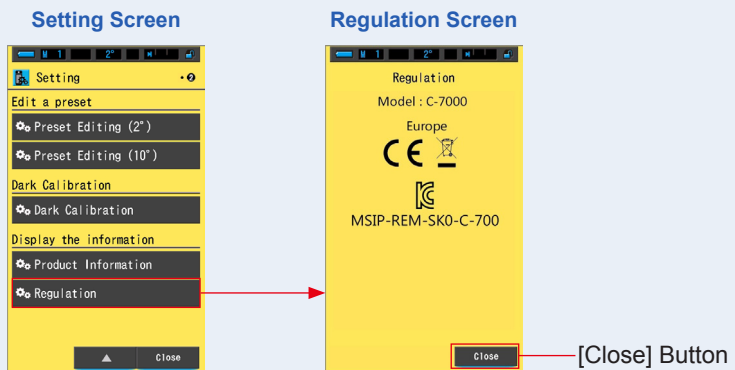

2. Touch the [Close] button.

Returns to Setting.

8. Hardware Setting Screen

The following items can be set on the Hardware Setting screen.

- Adjust Touch Panel
- Edit User Information
- Field of view
- Factory Setting

Hardware Setting Screen

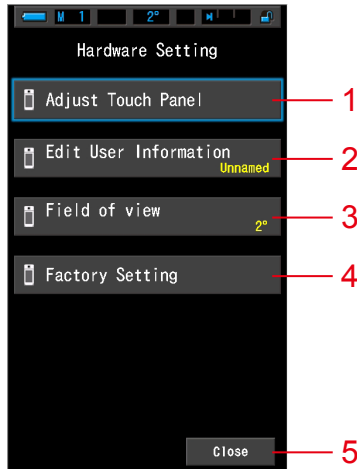

| No. | Item Name | Description |
|-----|------------------------------|--|
| 1 | Adjust Touch Panel | Adjust the positioning of touch panel display. (➔ P154) |
| 2 | Edit User Information | Edit user-input information which will be displayed on User Information position of the Product Information screen under the Settings function. (➔ P157) |
| 3 | Field of view | Select viewing angle 2° or 10°. (➔ P159) |
| 4 | Factory Setting | Returns all display and setting contents to the factory default. (➔ P161) |
| 5 | Close | Closes the Hardware Setting screen and returns to Display Mode Selection screen. |

Operation

1. While holding the Menu Button ⑥, press the Power Button ③.

* Continue to hold down both buttons for approximately 10 seconds until the Hardware Setting screen appears.

If the buttons are released before the Hardware Setting screen is displayed, the Measurement screen will be displayed.

The Hardware Setting screen will be displayed.

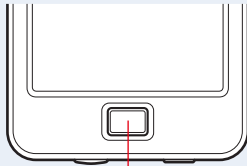

Menu Button ⑥

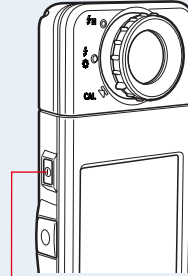

Power Button ③

2. Touch the desired menu item.

The setting screen of the selected item will be displayed.

Refer to the explanations on the following page for each item setting.

3. When completed, touch the [Close] button.

This will return the display to the Display Mode Selection screen.

8-1 Adjust Touch Panel

Adjust the position of touch panel display.

Adjust Touch Panel Screen

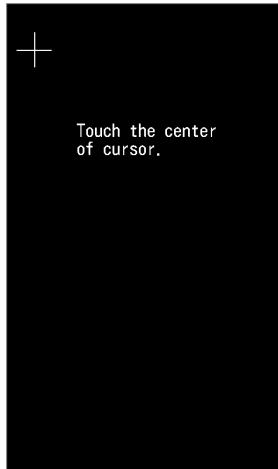

Operation

1. Touch the [Adjust Touch Panel] button on the Hardware Setting screen.

"Touch the center of cursor." will be displayed.

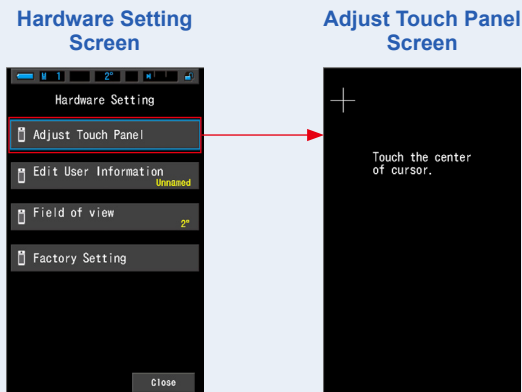

2. Touch the center of the white cross in the upper left corner of the screen.

The touch position will be shown as a coinciding red cross cursor, and the white cross cursor will appear at the next position.

Adjust Touch Panel Screen

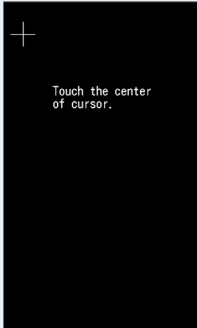

The touch position is showed with a red cross cursor

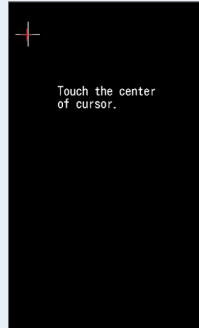

The white cross appears at the next position

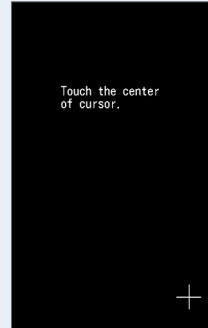

3. Repeat in 7 places.

Continue and repeat in 7 places.

When finished, "Press the "OK" to determine the touch panel adjustment." will be displayed.

Adjust Touch Panel Confirmation Screen

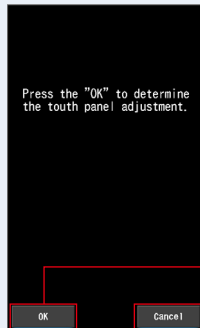

[OK] Button

[Cancel] Button

4. Touch the [OK] button.

Adjustment of touch panel is completed, and the display returns to the Hardware Setting screen.

To return to the Hardware Setting screen without adjusting the setting, touch the [Cancel] button.

Touch panel adjustment is completed.

 **NOTE**

When a point far from the white cursor is touched, the screen will blink to indicate adjustment failure.
Perform the adjustment again.

Adjust Touch Panel Screen

8-2 Edit User Information

User information can be entered in this screen.

User Information Screen



NOTE

Up to 16 alphanumeric characters can be entered.

Operation

1. Touch the [Edit User Information] button on the Hardware Setting screen.

The Edit User Information Input screen is displayed.

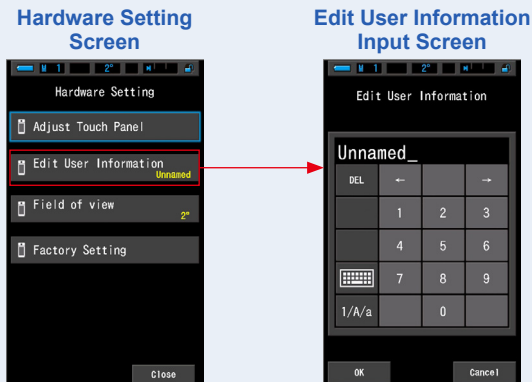

2. Edit the user information. (→ P19)

Edit User Information Input Screen

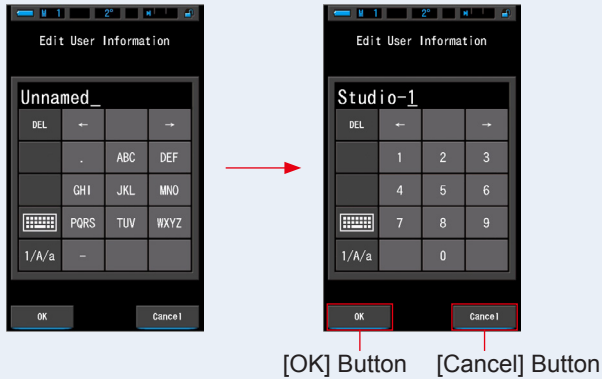

3. Touch the [OK] button.

Registers the user information, and returns to the Hardware Setting screen.

To return to the Hardware Setting screen without registering the user information, touch the [Cancel] button.

Hardware Setting Screen

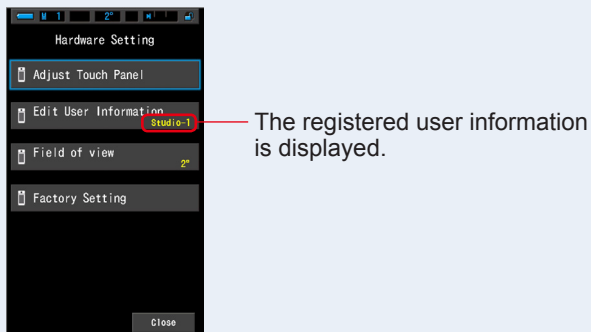

The user information is edited.

8-3 Field of View

Set the Field of view for measurement.



Operation

1. Touch the [Field of view] button on the Hardware Setting screen.
The Field of view screen is displayed.

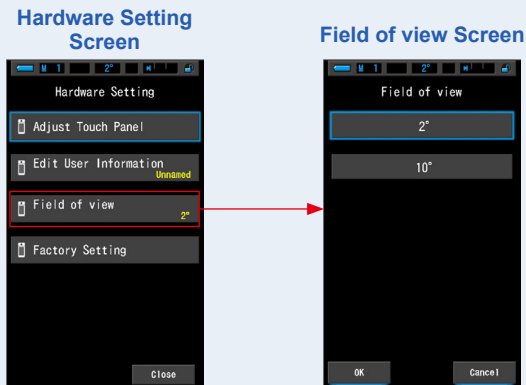

2. Set the Field of view.

Select viewing angle 2° or 10°.

Field of view Screen

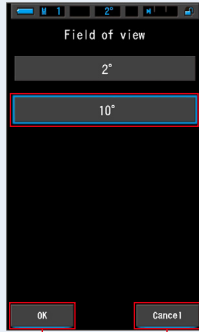

The selected button will be displayed encircled in blue.

[OK] Button [Cancel] Button

3. Touch the [OK] button.

Confirms the settings, and returns to the Hardware Setting screen.

To return to the Hardware Setting screen without confirming, touch the [Cancel] button.

Hardware Setting Screen

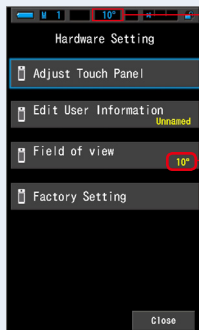

The selected setting is displayed on the status bar.

The set content is displayed.

The Field of view has been set.



NOTE

CIE standard observers help correlate instrumental color measurements to human visual assessments. The 2 degree field of view is common within quality control and other color evaluation procedures, particularly for food applications. The 10 degree field of view is considered to be more representative of how the human eye is commonly used with spectrophotometers for formulating and evaluating the color of various types of samples.

8-4

Factory Setting

Return all display and setting contents of the meter to the factory default.

Factory Setting Screen



Operation

1. Touch the [Factory Setting] button on the Hardware Setting screen.

The screen of "Reset to factory default settings. Are you sure?" will be displayed.

Hardware Setting Screen

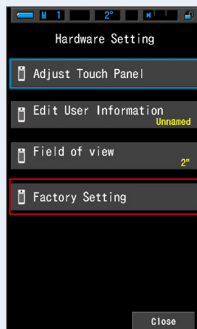

Factory Setting Screen

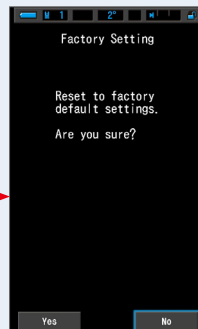

2. Touch the [Yes] button.

The factory setting confirmation message "All measurements will be lost when you perform this operation. Are you sure?" will be displayed.

Confirm again.

To return to the Hardware Setting screen without resetting to factory default settings, touch the [No] button.

Factory Setting Confirmation Screen

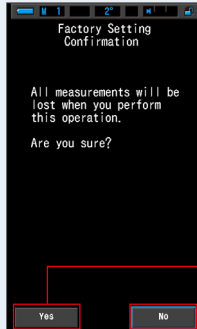

[Yes] Button

[No] Button

3. Touch the [Yes] button.



When the message "Deleting Memory. Please wait." or the progress bar is displayed, do not turn the power off. Otherwise, the meter may be damaged.

All measurement values are deleted, and the display returns to the Hardware Setting screen.

Factory Setting (Deleting) Screen Hardware Setting Screen

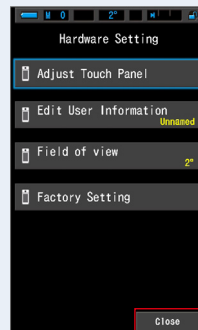

[Close] Button

4. Touch the [Close] button.

5. Dark calibration.

“Dark calibration in progress. Please wait” and the status bar will appear while calibrating. The Display Mode Selection screen will appear when operational.



Factory setting is completed.

9. Appendix

9-1

Glossary

| Term | Description |
|-------------------------------------|--|
| Color Temperature | <p>Color temperature refers to the chromaticity of a heated object (commonly refer to as a black body) that will vary according to its temperature. The color temperature is measured in units of Kelvin (K) and refers to the temperature of a heated object at a given color or chromaticity.</p> <p>The higher color temperature is, the bluer the light, and the larger the Kelvin value becomes. The lower the color temperature is, the redder the light, and the smaller the Kelvin value becomes.</p> <p>A figure that plots the changes of color temperatures on an xy chromaticity diagram is called the black body radiation locus.</p> |
| Correlated Color Temperature | <p>Not all light sources match the black body radiation locus when measuring light sources. In this case, the correlated color temperature is used. The correlated color temperature is a color temperature obtained by drawing an isothermperature line from the black body radiation locus which matches the measured value.</p> |
| Light | <p>This refers to the electromagnetic wavelength ranging from 380nm to 780nm that can be detected by the human eye.</p> |
| Black Body | <p>Theoretically, this is an object that absorbs all wavelengths and when heated, emits light equivalent to the applied color temperature.</p> |
| Black-body Radiation | <p>This refers to the light emitted by a black body.</p> <p>The amount of energy released for each wavelength changes with the applied color temperature, resulting in visible color variations.</p> |
| K | <p>Expressed in absolute Kelvin temperature, with units of "K". 0 (zero) K is equivalent to -273.15 °C or -459.67 °F.</p> |
| Δuv | <p>The deviation between the correlated color temperature and the black body radiation locus.</p> <p>When the correlated color temperature is above the black body radiation locus, a "+" sign is assigned; when below, a "-" sign is assigned.</p> |
| CRI (Color Rendering Index) | <p>Quantifies the faithfulness of color appearance under a measured light source as compared to the color appearance under a standard light source. Differences are expressed for individual hues, R1-R15, or as an average (Ra) of values R1 through R8.</p> |
| CIE1931 | <p>This is the trichromatic system based on the color matching function, $\bar{x}(\lambda)$, $\bar{y}(\lambda)$, and $\bar{z}(\lambda)$ that has been adopted by the CIE in 1931. (This is also called the XYZ color system that has a 2° viewing angle.) It is applied when the field of view is 4° or less.</p> |
| CIE1964 | <p>This is the trichromatic system based on the color matching function, $\bar{x}_{10}(\lambda)$, $\bar{y}_{10}(\lambda)$, and $\bar{z}_{10}(\lambda)$, which has been adopted by the CIE in 1964. (This is also called the XYZ color system that has a 10° viewing angle.) It is applied if the field of view exceeds 4°.</p> |
| CIE1976 | <p>This chromaticity diagram features a scale so that the sense of difference of colors with the same illuminance becomes proportional to the geometric distance on the diagram at all points of the chromaticity diagram, which was determined by the CIE in 1976. This is calculated by the formula based on tristimulus values X, Y and Z or chromaticity coordinates x and y of XYZ color system.</p> |

| Term | Description |
|---|---|
| Field of View | CIE standard observers help correlate instrumental color measurements to human visual assessments. The 2 degree field of view is common within quality control and other color evaluation procedures, particularly for food applications. The 10 degree field of view is considered to be more representative of how the human eye is commonly used with spectrophotometers for formulating and evaluating the color of various types of samples. |
| Photosynthetic Photon Flux Density | The photosynthetic photon flux density is the Photon is that the number of incident per unit time and unit area, needed for photosynthesis at a wavelength from 400nm to 700nm. The unit represent in $\mu\text{mol m}^{-2}\text{s}^{-1}$. |

9-2

Specifications

Type

- Spectrometer with CMOS linear image sensor

Illuminance meter class

- Conforms to JIS C 1609-1:2006 for General Class A Illuminance Meters
- Conforms to DIN 5032 Part 7 Class C

Light receiving method

- Incident light

Light receptor

- White diffuser (fixed type)

Light receptor element

- CMOS linear image sensor 128 pixels

Measurement system

- | | | |
|------------------|-----------------|--|
| • Measuring mode | • Ambient light | Ambient light mode |
| | • Flash light | Cord (PC) Flash mode Cordless Flash mode |
| <hr/> | | |
| • Display mode | | Text mode, Spectrum mode Spectrum Comparison mode, CRI mode CIE1931 (CIE1964) mode CIE1931 (CIE1964) Comparison mode CIE1976 mode CIE1976 Comparison mode |

Measuring item

- | | |
|--|--|
| • Tcp | Correlated Color temperature |
| • Δuv | Deviation |
| • X, Y, Z / X_{10} , Y_{10} , Z_{10} | Tristimulus value |
| • x, y, z / x_{10} , y_{10} , z_{10} | CIE1931(CIE1964)Chromaticity coordinates |
| • u' , v' / u'_{10} , v'_{10} | CIE1976 Uniform Chromaticity Scale |
| • λd / $\lambda d_{,10}$ | Dominant wavelength |
| • P_e / $P_{e,10}$ | Excitation purity |
| • λ_p | Peak wavelength |
| • Lux, fc / Hlx, Hfc | Illuminance / luminous exposure |
| • Ra | Average Color Rendering Index |
| • R1 ~ R15 | Special Color Rendering Index |
| • PPF/D | Photosynthetic Photon Flux Density |

Measurement range

- | | | |
|--------------------------------------|-----------------|---|
| • Illuminance | • Ambient light | 1lx to 200,000lx 0.1fc to 18,600fc (in limited version only) |
| • Luminous exposure | • Flash light | Range L: 20lx·s ~ 640lx·s (f/2.8 to f/16) Range H: 580lx·s ~ 20,500lx·s (f/16 to f/90) |
| • Photosynthetic Photon Flux Density | | 0.0 ~ 9999.9 $\mu\text{mol m}^{-2}\text{s}^{-1}$ |

Accuracy

- | | |
|---------------|--|
| • Illuminance | $\pm 5\% \pm 1$ digit of indicated value (Complies with JIS C1609-1:2006 general A class illuminometer) |
| • x y | ± 0.003 (Light source A, 800lx) |

Repeatability (2σ)

- | | |
|---------------|---|
| • Illuminance | 1% + 1digit (Light source A, 30lx ~ 200,00lx), 5% + 1digit (Light source A, 1lx ~ 29.9lx) |
| • x y | <ul style="list-style-type: none"> • 0.001 (Light source A, 500lx ~ 200,000lx) • 0.002 (Light source A, 100lx ~ 499lx) • 0.004 (Light source A, 30lx ~ 99lx) • 0.008 (Light source A, 5lx ~ 29.9lx) |

Spectral response characteristics

- | | |
|-------|---|
| • f1' | 9% or less (Complies with JIS C1609-1:2006 general A class illuminometer) |
|-------|---|

Oblique incident light characteristics

- | | |
|------|---|
| • f2 | 6% or less (Complies with JIS C1609-1:2006 general A class illuminometer) |
|------|---|

Temperature characteristics

- | | |
|---------------|---|
| • Illuminance | $\pm 5\%$ of indicated value (Complies with JIS C1609-1:2006 general A class illuminometer) |
| • x y | ± 0.006 (Light source A, 1000lx) |

Humidity characteristics

- | | |
|---------------|---|
| • Illuminance | $\pm 3\%$ of indicated value (Complies with JIS C1609-1:2006 general A class illuminometer) |
| • x y | ± 0.006 (Light source A, 1000lx) |

Display range

- | | |
|---------------------|--|
| • Color temperature | 1,563K ~ 100,000K (5lx ~ 200,000lx) |
| • Illuminance | <ul style="list-style-type: none"> • Ambient light 1lx ~ 200,000lx (3 significant digits) |
| • Luminous exposure | <ul style="list-style-type: none"> • Flash light 20 lx·s ~ 20,500 lx·s, 1.86 fc·s ~ 1,900 fc·s (3 significant digits) |
| • Shutter speed | <ul style="list-style-type: none"> • Flash light 1 second ~ 1/500 second |

Other functions

- | | |
|--------------------------------|------------------------------------|
| • Preset setting | • Preset 1 ~ 5 settings |
| • Setting | • 5 item settings |
| • Memory function | • Up to 999 measurements or titles |
| • Memory clear/recall function | |

- Out of measurement range or out of display range
- Battery capacity indicator display
- Automatic power OFF function
- LCD backlight
- Touch panel lock function
- Tripod socket
- [Under]/[Over] warning display
- With 4 level status icons
- Time elapsed after last operation: selectable from 20min., 10min., 5min., none
- Brightness can be selected from bright, normal, or dark
- Dimmer time after last operation: selectable from about 5second, about 10second, about 20second, about 40second, about 60second, none
- 1/4-inch, 20 threads

Display

- LCD display resolution
- 4.3 inch QVGA 480×800 dots

Recommended battery

- AA batteries
- USB bus-power
- 1.5V × 2 alkaline, manganese
- 5V/500mA or less (via USB cable when connected to computer)

Operating temperature

- -10°C ~ 40°C (without condensation)

Operating humidity

- 85%RH or less (at 35°C) (without condensation)

Transportation and storage conditions

- -10°C ~ 60°C (without condensation)

Dimensions

- Approx. 73 (width) × 183 (height) × 27 (depth) mm (excluding protruding part of light receiving) (max. thickness 40mm)

Weight

- (C-7000) approx. 230g (without batteries)

Included accessories

- CD-ROM (this Operating Manual and applications (Win)), Soft case, Strap, Start-up Guide, Safety Precaution



* Specifications and appearance described in this Operating Manual are subject to change without prior notice for improvement.

9-3

Legal Requirement

■ Legal Requirement

This product complies with the following legal requirements.

| Destination | Standard | | Details |
|---------------|---|--|---|
| Europe | CE  | SAFETY | IEC (EN) 61010-1:2010, 3rd Edition |
| | | EMC | EMS: EN55024:2010 EMI: EN55022:2010 EMC: EN61326-1:2013 |
| | | Wireless | R&TTE Directive 1999/5/EC EN300 220-2 V2.4.1 (2012-05) EN301 489-1 V1.9.2 (2011-09) EN301 489-3 V1.6.1 (2013-08) EN62479:2010 |
| | | Environmental | WEEE, RoHS, REACH |
| North America | FCC (US)  | EMC | FCC Part15 SubpartB ClassA |
| | | Wireless | FCC Part15 SubpartC |
| | IC (Canada) | EMC | ICES-003 |
| | | Wireless | RSS-210 Issue8 |
| Japan | | Environmental | Containers and Packaging Recycling Law |
| China | | Environmental | China RoHS (GB 189455) |
| South Korea | KC  | EMC | KN11, KN61000-4-2/-3/-4/-6/-8 |
| | | 1. 기자재의명칭 (모델명) :COLOR METER (C-7000) 2. 식별부호 : MSIP-REM-SK0-C-700 3. 상호명 : SEKONIC CORPORATION 4. 제조자 : SEKONIC CORPORATION 5. 제조국가 : 일본 | |

10. Optional Accessories

■ Synchro Cord

A convenient five-meter (=16.4 feet) long cord with three plugs, allowing you to connect and synchronize between a color meter, flash unit and camera, so there is no need to plug or unplug the cord during a shooting. Also, one terminal of the sync cord has a locking mechanism to ensure connection when used with a color meter.

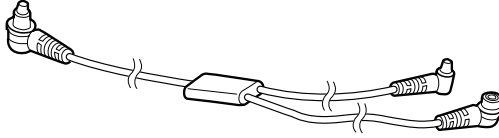

11. Troubleshooting

The following cases may not suggest failures. Please check again before requesting repair. When the meter does not function normally after checking the following, it may be damaged. Remove the battery, and ask the retailer or us to repair it.

| Status | Check item | Measure |
|--|---|---|
| It does not turn on (It does not display) | Are you pressing and holding the Power Button for one or more seconds? | Press and hold the Power Button for one or more seconds. |
| | Are $\oplus \ominus$ of the batteries inserted properly? | Check the $\oplus \ominus$ signs. (➔ P4) |
| | Are the batteries exhausted? | Replace the batteries. (➔ P9) |
| | Are the battery terminals dirty? | Wipe them off with a dry cloth. |
| | Are you using the specified batteries? | Check the batteries. (➔ P4) |
| The LCD does not respond | Is the screen locked? | Press and hold the Menu Button 6 to unlock the screen. (➔ P21) |
| The measurement cannot be made | Are you using the "C-700/C-7000 Series Utility"? | Stop using the "C-700/C-7000 Series Utility". |
| The measured values are wrong | Is the Light Selection Ring in the middle position? The light distribution characteristics change and suitable measurements cannot be made. | Rotate the Light Selection Ring until it clicks. |
| | Is the measuring mode wrong? (Such as measuring in Ambient Light Mode in flash light) | Check if the measuring mode is correct. (➔ P22) |
| | Are you using the pre-flash function when measuring in Cordless Flash Mode? | In Cordless Flash Mode, the measurement value of the main flash may not be displayed because the pre-flash is measured at first. Cancel the pre-flash function. |

| Status | Check item | Measure |
|------------------------------------|---|---|
| The memory function cannot be used | Is the differential measurement icon displayed? | The memory function cannot be used when the differential measurement icon is displayed. Cancel the differential measurement mode. |
| | Is "Memory Full" displayed when pressing the Memory Button? | The memory can store up to 999 values. Clear unnecessary memory values in advance, measure, and memorize it. |

SEKONIC CORPORATION

7-24-14, Oizumi-Gakuen-Cho, Nerima-Ku, Tokyo

178-8686 Japan

TEL +81-3-3978-2335

FAX +81-3-3978-5229

<http://www.sekonic.com>